

Smart
connections.

Operating manual

INVEOR Functional Safety

Legal notice

KOSTAL Industrie Elektrik GmbH
An der Bellmerlei 10
58513 Lüdenscheid
Germany
Tel. +49 (0)2351 16-0
Fax + 49 (0)2351 16-2400
info-industrie@kostal.com

Exclusion of liability

All names, trademarks, product names or other designations given in this manual may be legally protected even if not labelled as such (e.g.as brands). KOSTAL assumes no liability for their free usage.

The illustrations and texts have been compiled with great care. However, the possibility of errors cannot be ruled out. The compilation is made without any guarantee.

General note on gender equality

KOSTAL is aware of how language impacts on gender equality and always make an effort to reflect this in documentation. Nevertheless, for the sake of readability we are unable to use non-gender-specific terms throughout and use the masculine form instead.

© 2015 KOSTAL Industrial Electronics GmbH

All rights reserved by KOSTAL, including those of reproduction by photocopy and storage in electronic media. Commercial use or distribution of the texts, displayed models, diagrams and photographs appearing in this product are not permitted. This manual may not be reproduced, stored, transmitted or translated in any form or by means of any medium, in whole or in part, without prior written permission.

Contents

1.	General information	6
1.1	Information about documentation	7
1.1.1	Other applicable documents.....	8
1.1.2	Storing the documentation	8
1.2	Notes in this manual	9
1.2.1	Warnings	9
1.3	Symbols used in this manual	12
1.4	Labels on the drive controller.....	13
1.5	Qualified staff.....	14
1.6	Proper use.....	14
1.7	Responsibility	15
1.8	CE marking.....	15
1.9	Abbreviations.....	16
1.10	Certificate	18
2.	Safety	19
2.1	General safety instructions.....	20
2.2	STO safety instructions.....	20
2.2.1	Protection from electric shock	20
2.2.2	Protection from contamination.....	20
2.2.3	Elimination of errors	21
2.2.4	Elimination of errors with regard to short circuit	21
2.2.5	Visual inspection.....	21
2.2.6	Loss of the safety function	21
2.3	Safety classification / characteristic values.....	22
2.3.1	Definition of the necessary performance levels (PL _r) according to EN ISO 13849-1.....	22
2.3.2	Classification IEC 60204-1	23
2.3.3	Classification IEC 61800-5-2	24
2.3.4	Classification two-channel EN 62061 without external diagnosis	25
2.3.5	Classification two-channel EN 62061 with external diagnosis	26
2.3.6	Classification two-channel EN 62061, without dynamic testing	27
2.3.7	Classification two-channel EN ISO 13849-1 without external diagnosis	28
2.3.8	Classification two-channel EN ISO 13849-1 with external diagnosis	29
2.3.9	Classification two-channel EN ISO 13849-1 with dynamic testing	29
2.3.10	Classification one-channel (reduced SIL and PL)	30

3.	<i>Type key/scope of application</i>	31
3.1	Current type key	31
3.2	Future type key	32
4.	<i>Technical data</i>	33
4.1	Technical data, general	34
4.2	Technical data STO	34
5.	<i>Safety functions</i>	37
5.1	Control modes	38
5.2	STO function (Safe Torque Off)	39
5.2.1	STO without external diagnosis	40
5.2.2	STO with external diagnosis	41
5.2.3	STO with dynamic test	42
5.3	SS1 function (Safe Stop 1)	43
5.3.1	SS1	44
6.	<i>Application instructions - Safety</i>	45
6.1	Restarting protection	46
6.2	External STO input voltage	47
6.3	Digital input (not safety-related)	48
6.4	Internal auxiliary voltage	48
7.	<i>Parameterization</i>	49
7.1	STO	49
7.2	SS1	49
8.	<i>Diagnosis</i>	50
8.1	Diagnosis safety function	51
8.1.1	Carrying out an internal diagnosis	52
8.1.2	Carrying out external diagnosis	52
8.1.3	External dynamic test	53
9.	<i>Terminal assignment</i>	55
9.1	INVEOR connection diagram	56
9.2	Terminal assignment X310	57
9.3	Terminal assignment X5	58

- 10. Installation/disassembly/commissioning 60**
- 10.1 Installation 61
- 10.1.1 Connections size A "CANopen" / "Profibus" 62
- 10.2 Connections size A "EtherCAT" 63
- 10.3 Connections sizes B - C "CANopen" / "Profibus" 64
- 10.4 Connections sizes B - C "EtherCAT" 65
- 10.5 Connections size D "CANopen" / "Profibus" 66
- 10.6 Connections size D "EtherCAT" 67
- 10.7 STO connection cable 68
- 10.8 Disassembly 68
- 10.9 Commissioning 69
- 10.9.1 STO validation 69
- 10.9.2 SS1 Validation 69
- 11. Dealing with malfunctions 70**
- 11.1 Error detection and troubleshooting 71
- 11.2 Malfunction overview 72
- 11.3 Fault display 73
- 11.4 Fault-finding and troubleshooting 74
- 12. Maintenance 75**
- 12.1 Safety function 75
- 12.2 Checklist for maintenance 75
- 13. Index 76**
- 14. Overview: Tables / Figures 79**
- 14.1 List of tables 79
- 14.2 List of figures 80
- 14.3 Appendix: Commissioning 81
- 14.3.1 Quick-start guide for asynchronous motors 81
- 14.3.2 Quick-start guide for synchronous motors 82

1. General information

1.1	Information about documentation	7
1.1.1	Other applicable documents.....	8
1.1.2	Storing the documentation	8
1.2	Notes in this manual	9
1.2.1	Warnings	9
1.3	Symbols used in this manual	12
1.4	Labels on the drive controller.....	13
1.5	Qualified staff.....	14
1.6	Proper use.....	14
1.7	Responsibility	15
1.8	CE marking	15
1.9	Abbreviations.....	16
1.10	Certificate	18

Thank you for choosing an INVEOR drive controller from KOSTAL Industrie Elektrik GmbH! Our INVEOR drive controller platform is designed to be universally usable with all common motor types.

If you have any technical questions, please call our central service hotline:

Tel.: +49 (0)2331 80 40-848

Monday to Friday: 7 am to 5 pm (UTC/GMT +1)

Fax: +49 (0)2331 80 40-602

E-mail: INVEOR-service@kostal.com

Website address

www.kostal-industrie-elektrik.com

1.1 Information about documentation

The following information explains how to navigate through the documentation.

This documentation is a supplementary operating manual for the INVEOR drive controller. It contains all important information required for "Functional Safety".

Please carefully read the entire operating manual for the drive controller and the operating manual for functional safety. It contains important information for operating the INVEOR with "Functional Safety".

Then read this manual carefully in its entirety. It contains important information for operating the INVEOR.

We assume no liability for any damage resulting from non-observance of this manual.

This manual is a part of the product and should be stored in a safe place. It applies exclusively to the INVEOR from KOSTAL Industrial Electronics GmbH.

Provide the operator of the system with this manual so it is available when needed.

1.1.1 Other applicable documents

This refers to all manuals that describe how to operate the drive controller and any other manuals for all accessories used. Download the 3D files (.stp) for INVEOR and adapter plates from www.kostal-industrie-elektrik.com.

A description of parameters is available for download (www.kostal-industrie-elektrik.com) for parametrising the drive controller system.

In the download, you will find all the information required for correct parameterisation.

Designation
Operating manual for INVEOR drive controller

Table 1: Other applicable documents

1.1.2 Storing the documentation

Store this manual and all other applicable documents safely so they are available when needed.

1.2 Notes in this manual

1.2.1 Warnings

The warnings refer to life-threatening dangers. Serious injuries possibly resulting in death may occur.

Each warning consists of the following elements:

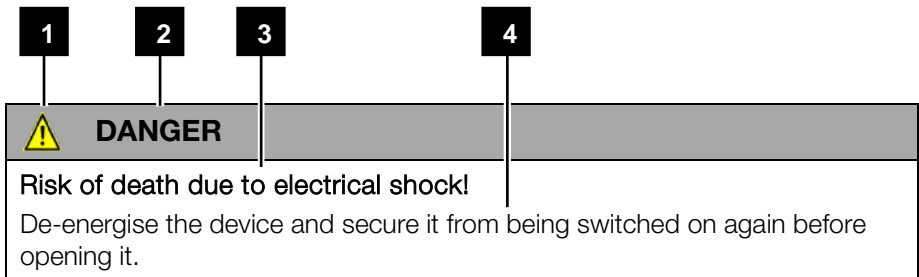

Fig.: 1 Structure of warnings

- 1 Warning symbol
- 2 Signal word
- 3 Type of danger
- 4 Corrective actions

Warning symbols



Danger



Danger due to electrical shock and discharge



Danger due to electromagnetic fields

Signal words

Signal words are used to identify the severity of the danger.

DANGER

Indicates a direct hazard with a high level of risk, which, if not avoided, will result in death or serious injury.

WARNING

Indicates a hazard with a moderate level of risk, which, if not avoided, will result in death or serious injury.

CAUTION

Indicates a hazard with a low level of risk, which, if not avoided, will result in minor or slight injury or property damage.

Information notes

Information notes contain important instructions for the installation and problem-free operation of the drive controller. These must be followed at all times. The information notes also point out that failure to observe can result in material or financial damage.



IMPORTANT INFORMATION

The drive controller may only be assembled, operated, maintained and installed by trained and qualified staff.

Fig.: 2 Example of an information note

Symbols within the information notes



Important information



Damage to property possible

Other notes



Additional information



Enlarged representation

1.3 Symbols used in this manual

Symbol	Meaning
1., 1., 3. ...	Consecutive steps in a handling instruction
→	Effect of a handling instruction
→	Final result of a handling instruction
■	List

Fig.: 3 Symbols and icons used

Abbreviations used

Abbreviation	Explanation
Tab.	Table
Fig.	Figure
It.	Item
Ch.	Chapter

1.4 Labels on the drive controller

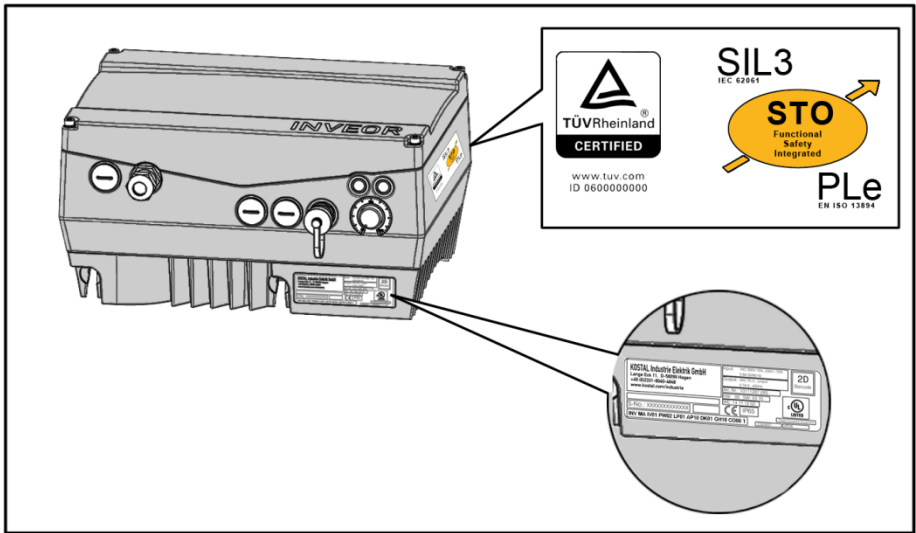





Fig.: 4 Labels on the drive controller

Signs and labels are applied to the housing of the drive controller. These signs and labels may not be altered or removed.

Symbol	Meaning
	Danger due to electrical shock and discharge
	Danger due to electrical shock and discharge. Wait two minutes (discharge time of the capacitors) after shut-down
	Additional earth connection
	Observe and read operating manual

1.5 Qualified staff

In the context of this operating manual, qualified staff are electronics specialists who are familiar with the installation, assembly, commissioning and operation of the drive controller and are aware of the dangers involved, and whose specialist training and knowledge of relevant standards and regulations provide them with the necessary abilities.

1.6 Proper use

If the device is installed in a machine, inverters may not be commissioned (i.e. intended operation may not begin) until it has been determined that the machine complies with the regulations of EC Directive 2006/42/EC (Machinery Directive); DIN EN 60204-1; VDE 0113-1:2007-06 must be observed.

Commissioning (i.e. beginning intended operation) is only permitted if the EMC Directive (2004/108/EC) is complied with.

The harmonised standards of DIN EN 50178; VDE 0160:1998-04 must be applied for this drive controller along with DIN EN 60439-1; VDE 0660-500:2005-01.

This drive controller may not be operated in areas where there is a danger of explosion.

Repairs may only be performed by authorised repair bodies. Independent and unauthorised intervention may result in death, injury or property damage. The warranty provided by KOSTAL will be invalidated in such cases.

External mechanical loads such as stepping on the housing are not permitted.



IMPORTANT INFORMATION

Using drive units in equipment that is not fixed is considered as an exceptional environmental condition and is only permitted if allowed by the standards and guidelines applicable on site.

1.7 Responsibility

As a basic principle, electronic devices are not fail-safe. The operator and/or the contractor setting up the machine or system is responsible for ensuring that the drive switches to a safe state if the device fails.

The “Electrical equipment of machines” section in DIN EN 60204-1; VDE 0113-1:2007-06, “Safety of machinery” describes the safety requirements for electrical control units. These are provided for the safety of people and machines and must be observed in order to retain the functional capability of the machine or system.

An emergency stop feature does not have to result in the power supply to the drive being switched off. To avoid dangerous situations, it may be useful for individual drives to remain operational or for specific safety procedures to be initiated. The effectiveness of emergency stop measures is evaluated by means of a risk assessment for the machine or system and its electrical equipment, and is determined by selecting a circuit category according to DIN EN 13849 “Safety of machinery – Safety-related parts of control systems”.

1.8 CE marking

With the CE marking, we, as the manufacturer of the device, confirm that the basic requirements of the following directive has been met:

- Directive on Electromagnetic Compatibility (Directive 2004/108/EC of the Council)

You can download the Declaration of Conformity from www.kostal-industrie-elektrik.com.

1.9 Abbreviations

All abbreviations used are listed in the following table:

Term	Definition
1oo2	"1 out of 2" structure according to IEC61508
STO	Safe Torque Off, safety function according to 61800-5-2, with which the commutation of the drive can be securely switched off.
SS1	<p>Safe Stop 1</p> <p>The SS1 safety function corresponds to an uncontrolled shut-down according to IEC 60204-1, stop category 1. In this case the drive controller does not monitor the motor delay or the motor speed securely.</p>
IGBT	Bipolar transistor with insulated gate electrode (Insulated Gate Bipolar Transistor)
Pulse block	Shut-down of the pulse pattern necessary for commutation by shutting down the driver supply
AOPD components	Active opto-electronic protective device
OSSD	<p>Output Signal Switching Device:</p> <p>The part of the active opto-electric protective device (AOPD) that is connected to the machinery control system and switched to OFF status when the sensor part is activated during correct operation.</p>

Continues on next page

Continuation

Term	Definition
DC	Diagnostic Coverage
SFF	Safe Failure Fraction
T	Lifetime
PL	Performance Level
PFH	Probability of a dangerous random hardware failure per hour
MTTFd	Mean Time to Failure
CCF	(also β value) Common Cause Failure
SRS	Safety Requirement Specification
PELV	Protected Extra Low Voltage
SELV	Safety Extra Low Voltage

Table 2: Abbreviations and terms

1.10 Certificate

EC Type-Examination Certificate





Functional Safety Type Approved

www.tuv.com
ID: 0600000000

Reg.-No.: 01/205/5419.00/14

Product tested	Safety function Safe Torque Off (STO) within the INVEOR frequency converters	Certificate holder	KOSTAL Industrie Elektrik GmbH Lange Eck 11 58505 Lüdenscheid Germany
Type designation	INVEOR, Details see Revision List		
Codes and standards	EN 61800-5-2:2007 EN 61800-5-1:2007 EN 61800-3:2004 + A1:2012 EN 62061:2005 + AC:2010 + A1:2013	EN ISO 13849-1:2008 + AC:2009 EN 60204-1:2006 + A1:2009 (in extracts) EN 61508 Parts 1-7:2010	
Intended application	The safety function STO complies with the requirements of the relevant standards (SIL CL 3 acc. to EN 61800-5-2 / EN 62061 / IEC 61508 and Cat. 4 / PL e acc. to EN ISO 13849-1) and can be used in applications up to SIL 3 acc. to EN 62061 / IEC 61508 and PL e acc. to EN ISO 13849-1.		
Specific requirements	The instructions of the associated Installation and Operating Manual shall be considered. In particular when used in Cat. 4 an external diagnostic device with additional dynamic test is mandatory.		

It is confirmed that the product under test complies with the requirements for machines defined in Annex I of the EC Directive 2006/42/EC.

Valid until 2019-10-23

The issue of this certificate is based upon an examination, whose results are documented in report-no.: 968/FSP 1052.00/14 dated 2014-10-23.
This certificate is valid only for products which are identical to the product tested. It becomes invalid at any change of the codes and standards forming the basis of testing for the intended application.



Köln, 2014-10-23

Certification Body for Machinery, NB 0035



Dipl.-Ing. Eberhard Frejno

90225 13 12/E 04 © TÜV, TÜV and TÜV are registered trademarks. Utilization and application require prior approval.

TÜVRheinland Industrie Service GmbH, Absatzstr. 36, 12003 Berlin / Germany
Tel.: +49 30 7952-1587, Fax: +49 30 7952-1370, E-Mail: industrieh-service@tis.tuv.com

www.fs-products.com
www.tuv.com



TÜVRheinland®
Genau. Richtig.

2. Safety

2.1	General safety instructions.....	20
2.2	STO safety instructions.....	20
2.2.1	Protection from electric shock.....	20
2.2.2	Protection from contamination.....	20
2.2.3	Elimination of errors.....	21
2.2.4	Elimination of errors with regard to short circuit.....	21
2.2.5	Visual inspection.....	21
2.2.6	Loss of the safety function.....	21
2.3	Safety classification / characteristic values.....	22
2.3.1	Definition of the necessary performance levels (PL _r) according to EN ISO 13849-1.....	22
2.3.2	Classification IEC 60204-1.....	23
2.3.3	Classification IEC 61800-5-2.....	24
2.3.4	Classification two-channel EN 62061 without external diagnosis.....	25
2.3.5	Classification two-channel EN 62061 with external diagnosis.....	26
2.3.6	Classification two-channel EN 62061, without dynamic testing.....	27
2.3.7	Classification two-channel EN ISO 13849-1 without external diagnosis.....	28
2.3.8	Classification two-channel EN ISO 13849-1 with external diagnosis.....	29
2.3.9	Classification two-channel EN ISO 13849-1 with dynamic testing.....	29
2.3.10	Classification one-channel (reduced SIL and PL).....	30

2.1 General safety instructions

See chapter 1.9 "Safety instructions" of the operating manual "INVEOR drive controller".

2.2 STO safety instructions

The safety instructions listed in the following are to be observed and obeyed strictly.

2.2.1 Protection from electric shock



IMPORTANT INFORMATION

No protection from electric shock is ensured by the STO status.



DANGER

Risk of death due to electrical shock!

Death or serious injury!

De-energise drive controller and secure it against being switched back on.

The following terminals may lead to dangerous currents even when the motor is not running:

- Supply terminals X1: L1, L2, L3
- Motor connection terminals X2: U, V, W
- PTC terminals T1/ T2

2.2.2 Protection from contamination



IMPORTANT INFORMATION

With open housing, contamination degree 2 must be observed in order to ensure the safety function.

2.2.3 Elimination of errors



IMPORTANT INFORMATION

The STO connection line must be shielded in order that the elimination of errors with regard to external voltage coupling may be applied. The EMC screw connection provided must be used for the cable inlet into the INVEOR housing.

2.2.4 Elimination of errors with regard to short circuit



IMPORTANT INFORMATION

With reference to the STO connection line, the "elimination of errors with regard to short circuit" is achieved in accordance with DIN EN 13849-2 in that a separate, shielded cable is used for each channel. Shielding is to be applied at both ends. The EMC screw connections provided must be used for this purpose.



IMPORTANT INFORMATION

If only one shielded cable is used for both STO channels, a safety switch must be used to detect possible crossovers between the channels to qualify for observation of the "elimination of errors short circuit" in accordance with DIN EN 13849-2.

2.2.5 Visual inspection



IMPORTANT INFORMATION

All cables are to be inspected for correct wiring prior to commissioning.

2.2.6 Loss of the safety function



IMPORTANT INFORMATION

Permanent 24 V voltage to the STO inputs results in the loss of the safety function.

2.3 Safety classification / characteristic values

INVEOR drive controllers have been designed to take account of the standards named in the following chapters. The safety classification and the corresponding characteristic values are also found there.

2.3.1 Definition of the necessary performance levels (PL_r) according to EN ISO 13849-1

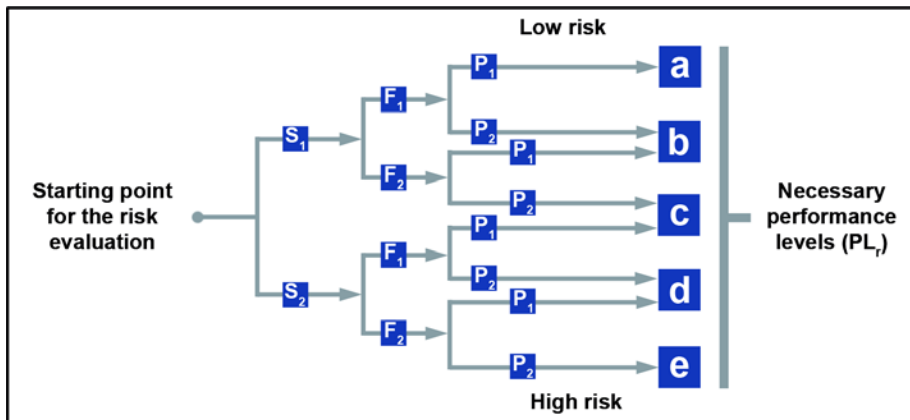

S - Severity of the injury

F - Frequency and/or duration of exposure to the hazard

P - Possibilities for avoiding the hazard

S₁ = slight injury (normally reversible)

F₁ = rare to frequently and/or short in duration

P₁ = possible under certain conditions

S₂ = serious injury, (normally irreversible) including death

F₂ = frequently to continuously and/or long in duration

P₂ = hardly possible

2.3.2 Classification IEC 60204-1

Three stop functions are named in the standard that are designated as categories 0 to 2. Categories 0 and 1 can be realised with INVEOR platform drive controllers with a pulse block.

Stop category-0

An uncontrolled shut-down through immediate interruption of the power supply to the machine drive elements (safety-related activation of the pulse block).

Stop category-1

Controlled shut-down. The power supply to the machine drive elements is initially maintained in order to achieve targeted shut-down. The power supply is interrupted following the standstill of the machine drive elements. (safety-related activation of the pulse block).



IMPORTANT INFORMATION

The process for the shut-down of the machine drive elements described under "Stop category-1" (SS1) can only be realised in connection with an additional external safety module!



IMPORTANT INFORMATION

"Stop category-2" (SS2) is not supported by the drive controller.

2.3.3 Classification IEC 61800-5-2

The following definitions describe the three types of safe stop function.

STO (Safe Torque Off)

No power is supplied to the motor that could cause rotation (or movement in the case of a linear motor). The drive controller supplies no power to the motor that could generate torque (or force in the case of a linear motor). This safety function corresponds to an uncontrolled shut-down according to IEC 60204-1, stop category 0.

**IMPORTANT INFORMATION**

This safety function can be used when it is necessary to shut off power in order to prevent an unexpected start.

**IMPORTANT INFORMATION**

Where there are external influences (e.g. falling of suspended loads), additional measures (e.g. mechanical braking), which must be designed to fail safe, may be necessary to prevent hazards.

**IMPORTANT INFORMATION**

In the STO status, the drive is not separated from the energy supply, as only the activation of the IGBTs is securely switched off.

Continues on next page

Continuation

Safe Stop 1 SS1

The SS1 safety function corresponds to an uncontrolled shut-down according to IEC 60204-1, stop category 1. In this case the drive controller does not monitor the motor delay or the motor speed securely.



IMPORTANT INFORMATION

Secure monitoring of the motor delay is only possible with the use of an external safety module.

Safe Stop 2 SS2

The SS2 function is not supported.

2.3.4 Classification two-channel EN 62061 without external diagnosis

The classification of the two-channel STO function without external diagnosis meets the following requirements:

Designation	Value	Explanation
Safety measure	Pulse block	---
SIL	3	Safety integrity level
PFH	1.81e-08	Probability of hazardous failures per hour
PFDav	1.22e-03	Average probability of a failure of the safety function on demand
DC	60 [%]	Diagnosis coverage
SFF	99.24 %	Proportion of safe failures
T	20 years	Duration of usage

Table 3: Classification two-channel EN 62061, without external testing

2.3.5 Classification two-channel EN 62061 with external diagnosis

The classification of the two-channel STO function with external diagnosis (see chapter 8.1.3) meets the following requirements:

Designation	Value	Explanation
Safety measure	Pulse block	---
SIL	3	Safety integrity level
PFH	2.16e-09	Probability of hazardous failures per hour
PFDav	1.66e-04	Average probability of a failure of the safety function on demand
DC	90 [%]	Diagnosis coverage
SFF	99.92 %	Proportion of safe failures
T	20 years	Duration of usage

Table 4: Classification two-channel EN 62061 with external diagnosis

2.3.6 Classification two-channel EN 62061, without dynamic testing

The classification of the two-channel STO function with dynamic testing (see chapter 8.1.3) corresponds to the following requirements:

Designation	Value	Explanation
Safety measure	Pulse block	---
SIL	3	Safety integrity level
PFH	1.45e-10	Probability of hazardous failures per hour
PFDav	1.24e-05	Average probability of a failure of the safety function on demand
DC	99 [%]	Diagnosis coverage
SFF	99.99 %	Proportion of safe failures
T	20 years	Duration of usage

Table 5: Classification two-channel EN 62061, with enhanced external testing

2.3.7 Classification two-channel EN ISO 13849-1 without external diagnosis

The classification of the two-channel STO function without external diagnosis meets the following requirements:

Designation	Value	Explanation
Safety measure	Pulse block	---
PL	e	Performance level
Category	3	---
MTTFd	167 [a]	Mean time to failure (dangerous)
DC	60 [%]	Diagnosis coverage
T	20 years	Duration of usage

Table 6: Classification two-channel EN ISO 13849-1 without external testing



IMPORTANT INFORMATION

Cat.3 with DC = 60% actually limits the performance level to d. However, the increased failure-safety present in this case and documented in the context of the FMEA is of equal value, and PL e is thus achieved.

2.3.8 Classification two-channel EN ISO 13849-1 with external diagnosis

The classification of the two-channel STO function with external diagnosis (see chapter 8) corresponds to the following requirements:

Designation	Value	Explanation
Safety measure	Pulse block	---
PL	e	Performance level
Category	3	---
MTTFd	167 [a]	Mean time to failure (dangerous)
DC	90 [%]	Diagnosis coverage
T	20 years	Duration of usage

Table 7: Classification two-channel EN ISO 13849-1 with external diagnosis

2.3.9 Classification two-channel EN ISO 13849-1 with dynamic testing

The classification of the two-channel STO function with dynamic testing (see chapter 8) corresponds to the following requirements:

Designation	Value	Explanation
Safety measure	Pulse block	---
PL	e	Performance level
Category	4	---
MTTFd	167 [a]	Mean time to failure (dangerous)
DC	99 [%]	Diagnosis coverage
T	20 years	Duration of usage

Table 8: Classification two-channel EN ISO 13849-1 with enhanced external testing

2.3.10 Classification one-channel (reduced SIL and PL)

The one-channel classification is the result of parallel connection of the two STO inputs. The safety classification is thus reduced to the following values.



IMPORTANT INFORMATION

The classification can be reduced due to false connection technology (e.g. one-channel) during installation/planning!



IMPORTANT INFORMATION

An external 1-channel structure, bridged to both STO inputs, means that the safety level no longer meets SIL3 or PL_e.

Designation	Value	Explanation
Safety measure	Pulse block	---
SIL	1	Safety Integrity Level
PFH	1.81e-08	Probability of hazardous failures per hour
SFF	99.24 %	Proportion of safe failures
T	20 years	Duration of usage
PL	c	Performance level
Category	1	---
MTTFd	56 years	Mean time to failure (dangerous)
DC	60 [%]	Diagnosis coverage

Table 9: Classification one-channel IEC 61508 and EN ISO 13849



IMPORTANT INFORMATION

When an external control system carries out a test of the connection in the application 100 times more often than a "sharp" requirement of the STO function, SIL 2 and PL d are achieved.

3. Type key/scope of application

The INVEOR drive controller platform contains variants with and without safety function STO. These variants are clearly recognisable by the product key. The STO safety function cannot be retrofitted.

3.1 Current type key

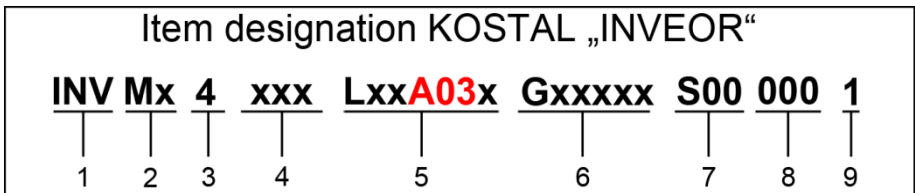

Fig.: 5 Item designation (current)

Key	
1 Drive controller series: INVEOR	6 Housing: G0 – standard (black with inscription); 0 – standard (cooling elements); 0 – standard (with potentiometer); 00 – standard screw connections
2 Installation location/size: M-motor-integrated, size: A, B, C, D	7 Firmware version: S00 – standard
3 Input voltage: 2 – 230 V, 4 – 400 V	8 Model: 000 standard; 001 specific
4 Recommended motor power: 0.55; 0.75; 1.1; 1.5; 2.2; 3.0; 4.0; 5.5; 7.5; 11; 15; 18.5; 22 kW	9 Equipment generation: 1 – current version
5 Printed circuit boards: L00 – Standard (without brake chopper); A00 – Standard (without TTL evaluation); A03 – Safety application printed circuit board A03- – No fieldbus A031 – Profibus A032 – CANopen A033 – EtherCAT A034 – ProfiNet A036 – Sercos III	

Continues on next page

3.2 Future type key

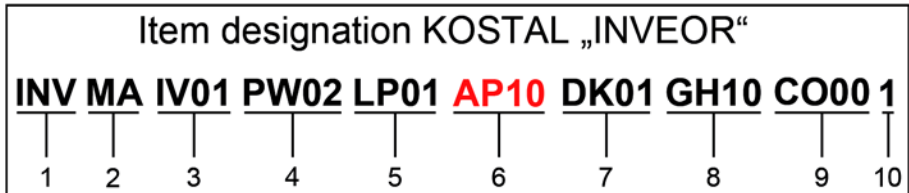

Fig.: 6 Item designation (future)

The following table provides an overview of devices with STO function:

Key	
1 Drive controller series: INVEOR	6 Application printed circuit board: AP01 – Standard AP10 – Functional safety AP20 – Functional safety + Profibus AP21 – Functional safety + CANopen AP22 – Functional safety + EtherCAT AP23 – Functional safety + ProfiNet AP24 – Functional safety + Sercos III
2 Installation location/size: M-motor-integrated, size: A - D	7 Cover: DK01 – Standard
3 Input voltage: IV01 – 400 V	8 Housing: GH10 – Standard cooling elements (painted black)
4 Recommended motor power: PW02 (0.37 kW); PW03 (0.55 kW); PW04 (0.75 kW); PW05 (1.1 kW); PW06 (1.5 kW); PW07 (2.2 kW); PW08 (3.0 kW); PW09 (4.0 kW); PW10 (5.5 kW); PW11 (7.5 kW); PW12 (11 kW); PW13 (15 kW); PW14 (18.5 kW); PW15 (22 kW)	9 Firmware version: CO00 – Standard CO01 - Specific
5 High-performance printed circuit board: LP01 – Standard LP02 – With brake chopper	10 Equipment generation: 1 – current version

4. Technical data

4.1	Technical data, general.....	34
4.2	Technical data STO	34

4.1 Technical data, general

See chapter 8 "Technical data" of the operating manual "INVEOR drive controller".

4.2 Technical data STO

Designation	Value	Unit
STO max. response time	50	ms
PELV/SELV power supply for STO input voltage (rating)	24	VDC
PELV/SELV tolerance for STO input voltage (referring to rating)	± 25	%
Current consumption per STO channel with rated voltage	typ. 65	mA
Start-up peak current (2.5 ms)	400	mA
Compatibility: Max. OSSD pulse	1	ms
Compatibility: Min. OSSD pulse period time	10	ms
STO Input Low	0..5	V
STO Input High	18..30	V
STO Input High when operating with OSSD signals	19.2..30	V

Table 10: Technical data STO

The STO response time is the time between the deactivation of the STO input signal to the definite fail-safe pulse block.

Continues on next page

Continuation

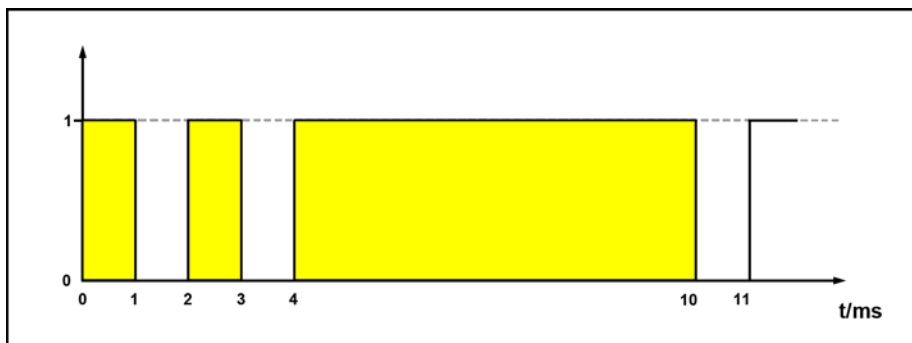

Fig.: 7 OSSD test pulses, in this case 2 test pulses

Continues on next page

Continuation

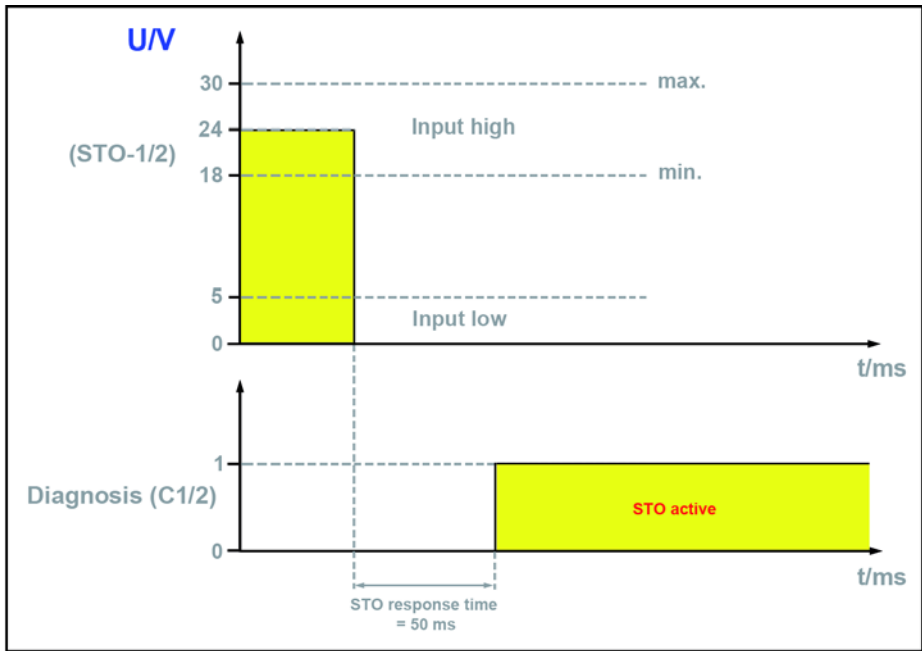

Fig.: 8 STO input



IMPORTANT INFORMATION

The maximum STO response time of 50 ms is to be taken into account when using the machine.

5. Safety functions

5.1	Control modes.....	38
5.2	STO function (Safe Torque Off).....	39
5.2.1	STO without external diagnosis	40
5.2.2	STO with external diagnosis	41
5.2.3	STO with dynamic test	42
5.3	SS1 function (Safe Stop 1).....	43
5.3.1	SS1	44

In order to prevent the endangerment of people and the environment, as well as damage to material, it is necessary to be able to safely shut down machines in the event of a dangerous situation. To this purpose, the "safety variants" of the INVEOR platform are equipped with the safety function "Safe Torque Off" (STO).

In the following chapters, the principles of "STO and SS1" safety functions, as well as the fundamental parameter "reaction time" will be described and explained.

5.1 Control modes

The STO function is effective at a higher level in all drive controller operating modes.

5.2 STO function (Safe Torque Off)

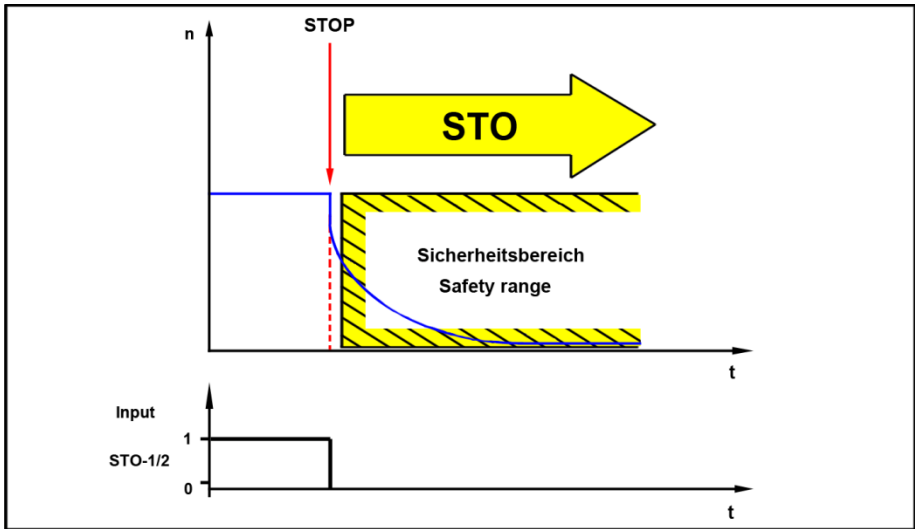

Fig.: 9 Safety function STO

A PELV/SELV 24V power supply must be provided for the STO control.



IMPORTANT INFORMATION

In the STO status, the drive controller and the motor are not separated from the energy supply, as only the commutation of the motor is switched off.

After the STO function is triggered, the drive is switched off (impulse block) and the drive control runs down without braking (when no brake has been activated).



IMPORTANT INFORMATION

The shut-down time must be considered in this application.

5.2.1 STO without external diagnosis

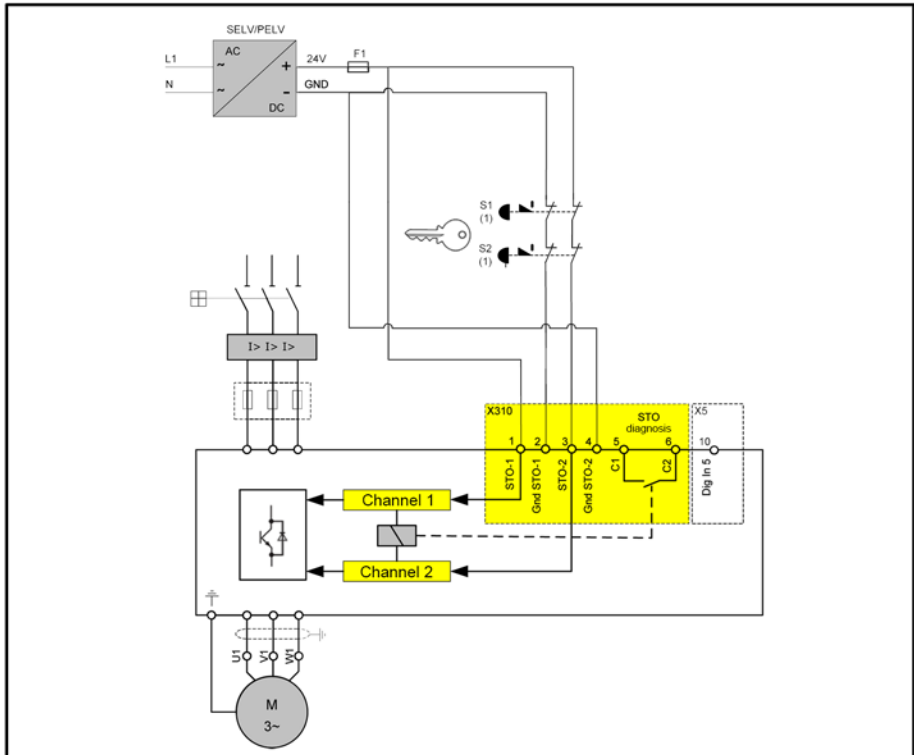

Fig.: 10 STO without external diagnosis

Category 3,

PL e according to EN ISO 13849-1

Level SIL 3 according to EN IEC 62061

Stop category 0

- (1) Emergency stop switch (S1): Request for a free-running stop and activation of the safety function "safe torque off".
- (2) Push button (S2): Resetting the OSSD switching device.

5.2.2 STO with external diagnosis

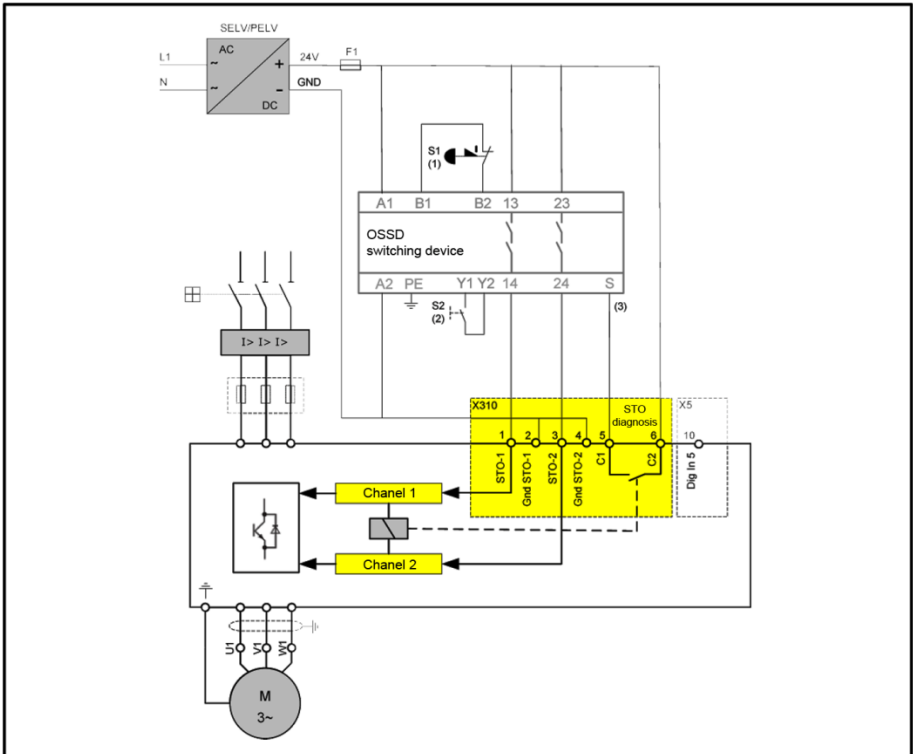

Fig.: 11 STO with external diagnosis

Category 3,

PL e according to EN ISO 13849-1

Level SIL 3 according to EN IEC 62061

Stop category 0

- (1) Emergency stop switch (S1): Request for a free-running stop and activation of the safety function "safe torque off".
- (2) Push button (S2): Resetting the OSSD switching device.
- (3) Response of safety branch of external control.

5.2.3 STO with dynamic test

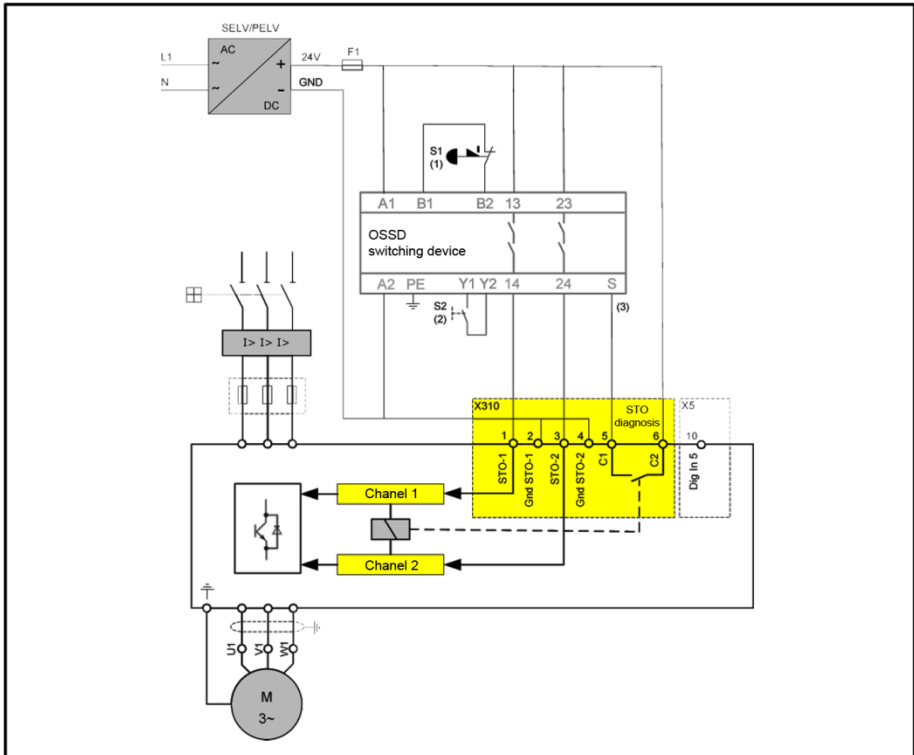

Fig.: 12 STO with dynamic test

Category 4,

PL e according to EN ISO 13849-1

Level SIL 3 according to EN IEC 62061

Stop category 0

- (1) Emergency stop switch (S1): Request for a free-running stop and activation of the safety function "safe torque off".
- (2) Push button (S2): Resetting the OSSD switching device.
- (3) Response of safety branch of external control.

See also chapter 8.1.3 "External dynamic test"

5.3 SS1 function (Safe Stop 1)

Following activation of function SS1, the drive is decelerated by the drive controller. The STO status is assumed after expiration of the parameterisable SS1 time. The brake ramp is not monitored in the process.

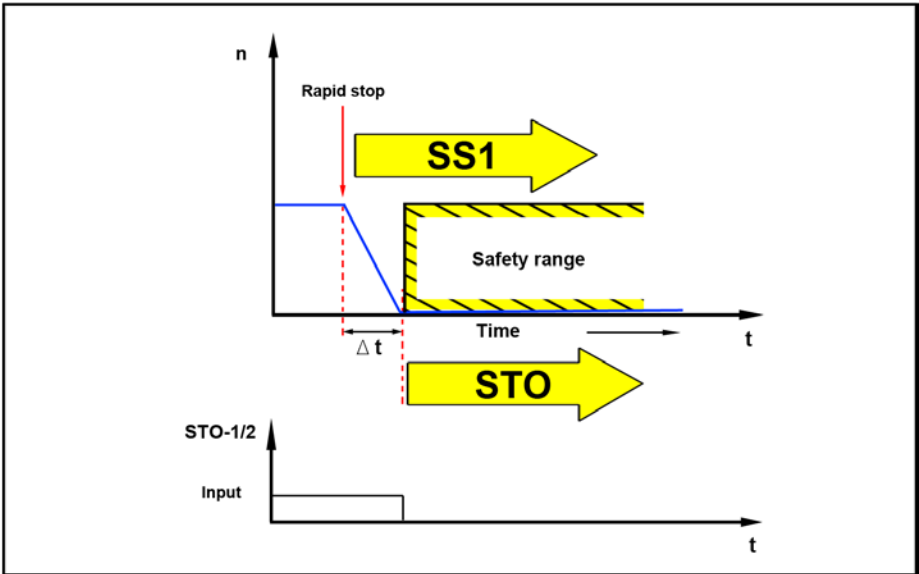

Fig.: 13 Safety function SS1 without monitoring with brake ramp

5.3.1 SS1

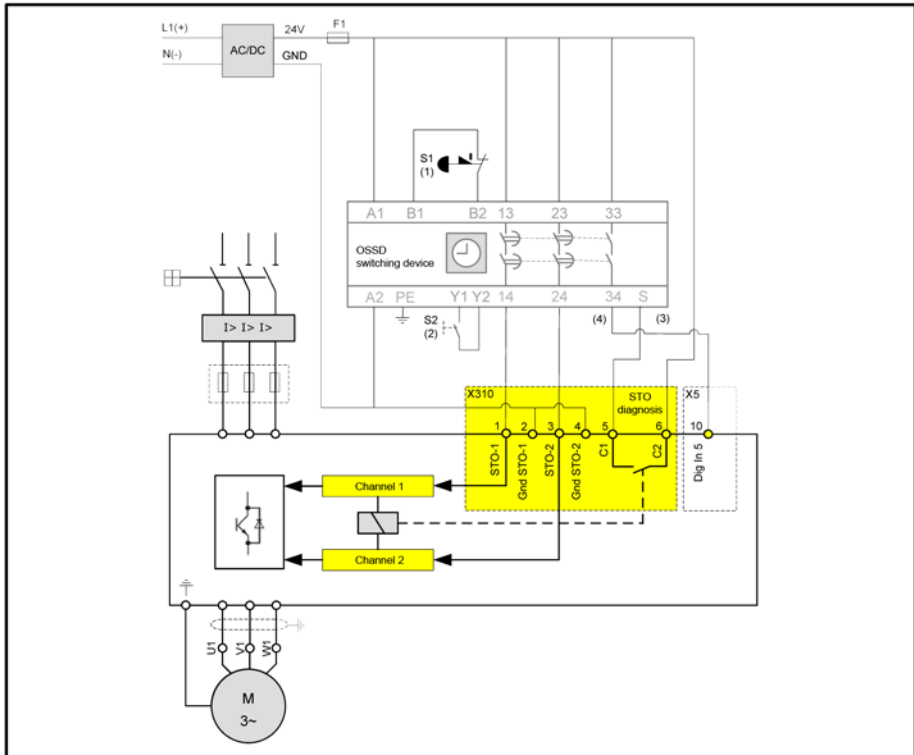

Fig.: 14 SS1 function

Category 3, dynamic test is not necessary

Category 4, dynamic test necessary (see previous chapter)

PL e according to EN ISO 13849-1

Level SIL 3 according to EN IEC 62061

Stop category 1

- (1) Emergency stop switch (S1): Request for a free-running stop and activation of the safety function "safe torque off".
- (2) Push button (S2): Resetting the OSSD switching device.
- (3) Response of safety branch of external control.
- (4) The emergency stop starts the fast delay ramp (rapid stop) by way of the input Dig In5. Following expiration of the time stored in the OSSD switching device, the secure stop is triggered.

6. Application instructions - Safety

6.1	Restarting protection	46
6.2	External STO input voltage	47
6.3	Digital input (not safety-related).....	48
6.4	Internal auxiliary voltage	48

In order to clearly explain the wiring of the INVEOR frequency converter, the fundamental connection examples will be presented in the following chapters.

6.1 Restarting protection



IMPORTANT INFORMATION

In the event of dangerous loads having an external effect, a hazard can originate from the STO status when no further measures are taken.

In addition to the switching examples, the instructions on the subject of "Restarting" from the standards DIN EN ISO 13849-1 (BGIA Report 2/2008) and IEC 60204 are to be considered.

The resetting of a safety requirement alone may not automatically result in the restarting of the drive. Restarting may only be made possible through a fault acknowledgement (manual reset) at the safety switching device.



IMPORTANT INFORMATION

With appropriate parameterization, it is possible that the drive controller will start up automatically (see chapter 7).

6.2 External STO input voltage

In order that the electrical values for low voltage with safe separation in the switching of the STO function cannot be exceeded, a 24 V power supply must be used that corresponds to the PELV or SELV provisions in accordance with EN 60204-1.

The 24 V power supply used for the STO supply must be adequate for the grid-side voltage interruption defined in EN 60204-1.

6.3 Digital input (not safety-related)

The digital input 5 on the frequency converter serves to realise the SS1 function, but is not designed to be of relevance to safety. The input is exclusively used for the activation of the rapid stop until standstill.

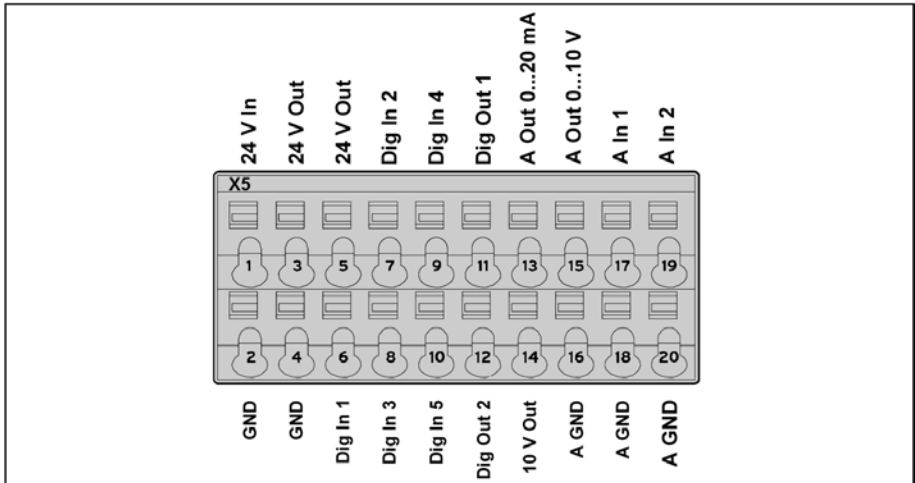

Fig.: 15 Digital input (not safety-related)

6.4 Internal auxiliary voltage

The 24 V supply of the application PCB is found in accordance with the SELV/PELV requirement on terminal X5 and can be used as supply voltage for the STO channels. In this application case, a max. of 30 mA is available for additional external components.

7. Parameterization

See chapter 5 "Parameters" of the operating manual "INVEOR drive controller". We recommend deactivating the "auto acknowledgement" of a fault (Parameter 1.181), as otherwise an immediate restart can occur as soon as the fault is no longer present.

7.1 STO

The restart protection (not safety-related, parameter 1.132) should under no circumstances be deactivated, as otherwise an immediate restart can occur when the STO voltage is activated.

7.2 SS1

The following parameter is to be set for the safety function SS1 with external safety components:

a) Rapid stop

1.088	Rapid stop		Unit: s	
Relationship to parameter:	Parameter manual: P. xy	Transfer status: 2	min.: 0.1	own value (enter!)
			max.: 1.000	
			def.: 10	
<p>The rapid stop parameter prescribes the time that the inverter requires to brake to 0 Hz from the max. speed (1.021). If the set rapid stop time cannot be achieved, the fastest possible deceleration time is implemented.</p>				

Table 11: SS1 parameter rapid stop (not safety-related)

8. Diagnosis

8.1	Diagnosis safety function	51
8.1.1	Carrying out an internal diagnosis	52
8.1.2	Carrying out external diagnosis.....	52
8.1.3	External dynamic test	53

The status of the STO function is signalled with the help of a potential-free diagnosis contact that is locked in the safe status. The two-channel, deactivated impulse block is thus displayed. This contact can be used as a response to a higher level control unit.

8.1 Diagnosis safety function

STO 1	STO 2	Contact	Note
Off	Off	closed	Neither STO channel is supplied: STO active
On	Off	open	Status implausible: Channels show unequal result
Off	On	open	Status implausible: Channels show unequal result
On	On	open	Both STO channels are supplied: Operation possible

Table 12: Diagnosis overview of diagnosis contact



IMPORTANT INFORMATION

The maximum delay time between the activation of the safety function by the input-side safety device and the closing of the contact is 50 ms.



IMPORTANT INFORMATION

This reaction time is to be observed when using the machine and configured in accordance with the external fault diagnosis.

8.1.1 Carrying out an internal diagnosis

The status of the two STO channels is monitored internally for plausibility with no relevance for safety. It is thereby expected that the statuses of the two channels are identical. If the statuses should be unequal for more than 2 seconds, the frequency converter changes to the fault status. Only when both channels have the same status can the fault be acknowledged and operation be possible. The achieved diagnosis coverage DC through internal monitoring amounts to 60 %.

8.1.2 Carrying out external diagnosis

An external diagnosis is necessary in order to achieve diagnosis coverage of 90% and the resulting safety parameters. The diagnosis contact is thereby monitored for plausibility in accordance with the statuses of the STO inputs. This means, for STO channels that are not supplied, that the internal diagnosis relay short-circuits the contacts C1 and C2 (normally open contact). As soon as the STO channels are supplied with 24 V, the relay falls and the contacts C1 and C2 are interrupted. Carry out a diagnosis prior to every start-up of the motor.

8.1.3 External dynamic test

An external dynamic test is necessary in order to achieve diagnosis coverage of 99% and the resulting safety parameters. The STO channels are supplied with all possible logical statuses and the expected status of the diagnosis relay is queried before each motor activation is enabled.

Process:

1. STO1 and STO2 not supplied with 24 V => Relay is closed
2. STO1 and STO2 supplied with 24 V => Relay opens
3. Only supply STO1 with 24 V => Relay remains open
(otherwise fault in channel 2)
4. Only supply STO2 with 24 V => Relay remains open
(otherwise fault in channel 1)
5. STO1 and STO2 supplied with 24 V => Motor can be activated

Continues on next page

Continuation

Process diagram:

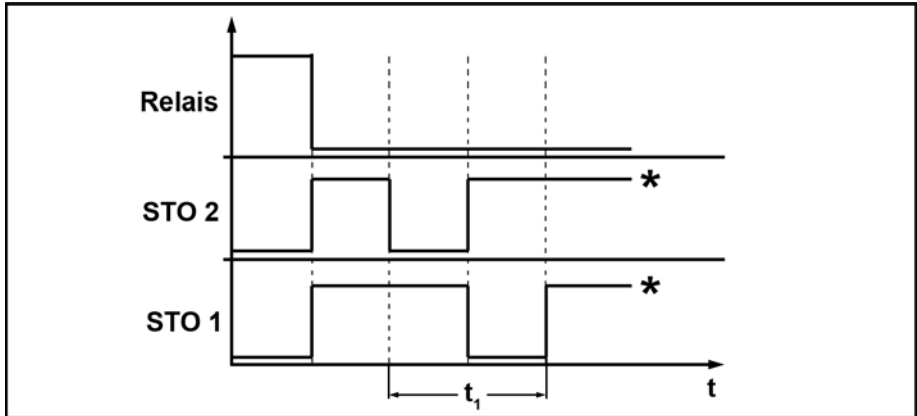

Fig.: 16 External dynamic test

* Motor can be activated

$t_1 < 2$ seconds, as the STO implausibility fault will otherwise be triggered.

With this the dynamic test is concluded and the motor can be started.



IMPORTANT INFORMATION

During the dynamic test, the reaction times of the STO switching are to be considered:

Delay of the diagnosis relay max. 50 ms

Activation of the fault "STO implausible" 2 seconds



IMPORTANT INFORMATION

The maximum test interval is 1 year.

9. Terminal assignment

9.1	INVEOR connection diagram	56
9.2	Terminal assignment X310	57
9.3	Terminal assignment X5	58

9.1 INVEOR connection diagram

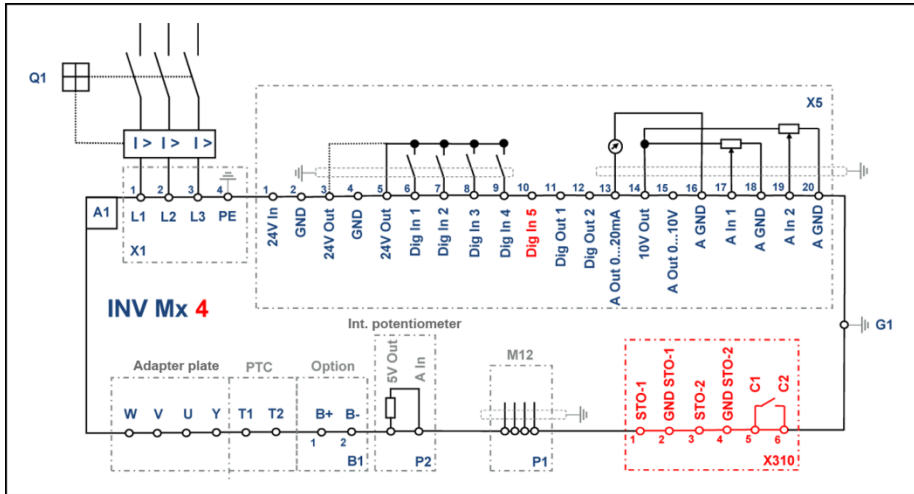

Fig.: 17 Control connections

Characters	Explanation
A1	Drive controller of type INVEOR Mx 4 (3~ 400 V)
B1	Connection for external brake resistor (option)
G1	M6 grounding screw (connection for residual currents > 3.5 mA)
P1	RS485 programming interface (M12 plug)
P2	Internal potentiometer
Q1	Motor protection switch or load break switch (optional)
X1	Mains terminals
X5	Digital/analogue inputs and outputs
X310	Digital inputs and outputs for functional safety (option)

The input terminal X310 serves the purpose of input-side connection of electromechanical and electronic safety switching devices.

In addition to the safety-related inputs, the response contacts are available on terminals X310.5 and X310.6 (diagnosis).

9.2 Terminal assignment X310

Control connections for functional safety

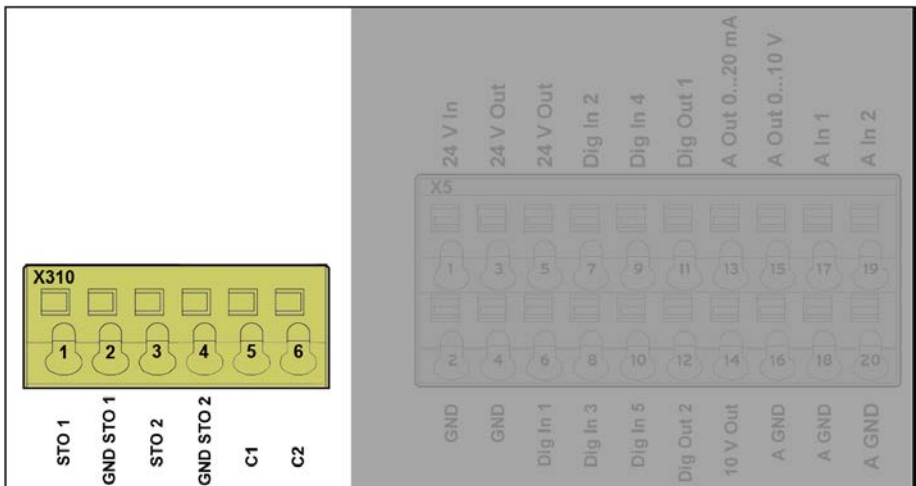

Fig.: 18 Terminal assignment X310

Terminal no.	Designation	Assignment
1	STO 1	Control input 1 for the function STO (0 V/24 V)
2	GND STO 1	Reference potential STO 1 (0 V)
3	STO 2	Control input 2 for the function STO (0 V/24 V)
4	GND STO 2	Reference potential STO 2 (0 V)
5	C1	Normally open contact for response of STO to external control system (diagnosis)
6	C2	Normally open contact for response of STO to external control system (diagnosis)

Continues on next page

Continuation

9.3 Terminal assignment X5

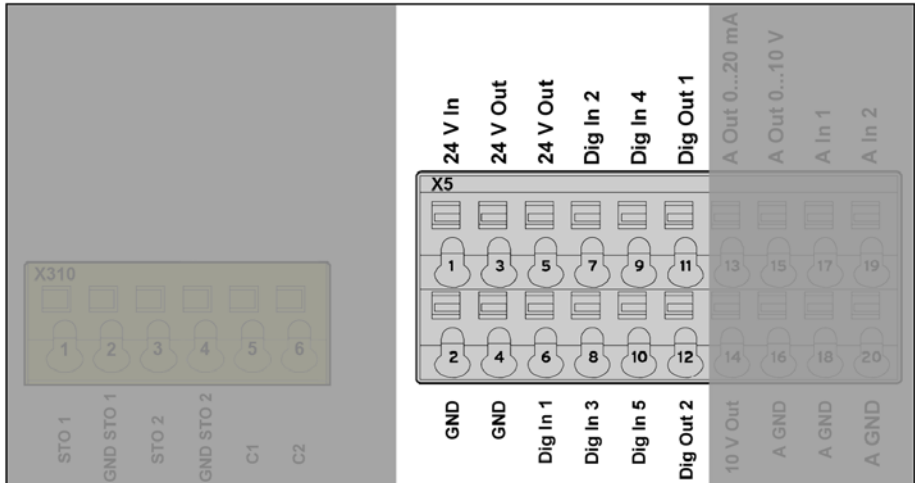
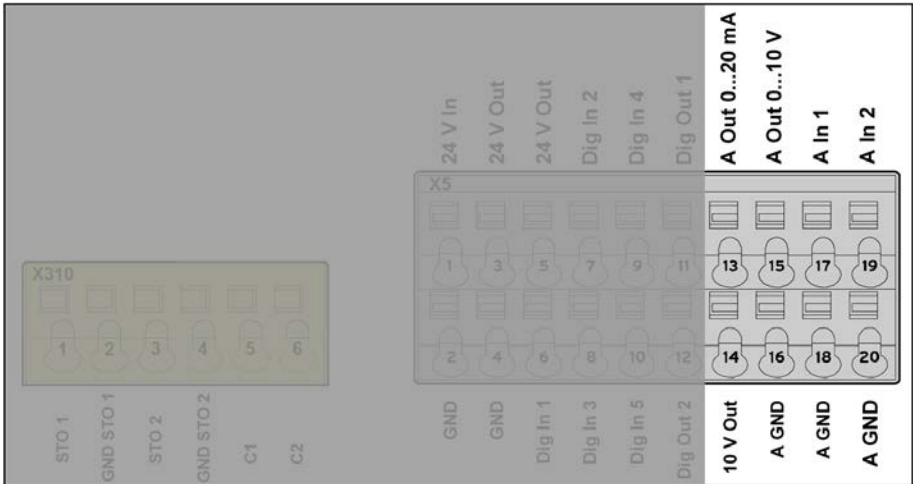

Fig.: 19 Terminal assignment X5

Terminal no.	Designation	Assignment
1	24 V In	Ext. power supply
2	GND (ground)	Ground
3	24 V Out	Int. power supply
4	GND (ground)	Ground
5	24 V Out	Int. power supply
6	Dig. In 1	Target value enable (parameter 1.131)
7	Dig. In 2	Free (not assigned)
8	Dig. In 3	Free (not assigned)
9	Dig. In 4	Error reset (parameter 1.180)
10	Dig. In 5	Rapid stop
11	Dig. Out 1	Fault message (parameter 4.150)
12	Dig. Out 2	Free (not assigned)

Continues on next page

Continuation



Terminal no.	Designation	Assignment
13	A. Out 0 ... 20 mA	Actual frequency (parameter 4.100)
14	10 V Out	For ext. voltage divider
15	A. Out 0 ... 10 V	Actual frequency (parameter 4.100)
16	A GND (ground 10 V)	Ground
17	A. In 1	PID actual value (parameter 3.060)
18	A GND (Ground 10 V)	Ground
19	A. In 2	Free (not assigned)
20	A GND (ground 10 V)	Ground

10. Installation/disassembly/commissioning

10.1	Installation	61
10.1.1	Connections size A "CANopen" / "Profibus"	62
10.2	Connections size A "EtherCAT"	63
10.3	Connections sizes B - C "CANopen" / "Profibus"	64
10.4	Connections sizes B - C "EtherCAT"	65
10.5	Connections size D "CANopen" / "Profibus"	66
10.6	Connections size D "EtherCAT"	67
10.7	STO connection cable	68
10.8	Disassembly	68
10.9	Commissioning	69
10.9.1	STO validation	69
10.9.2	SS1 Validation	69

The installation and disassembly instructions, as well as the information concerning commissioning refer in this document only to the subject area of "functional safety".

10.1 Installation

See chapter 1 "General information" of the operating manual "INVEOR drive controller".



IMPORTANT INFORMATION

With open housing, contamination degree 2 must be observed in order to ensure the safety function.

10.1.1 Connections size A "CANopen" / "Profibus"

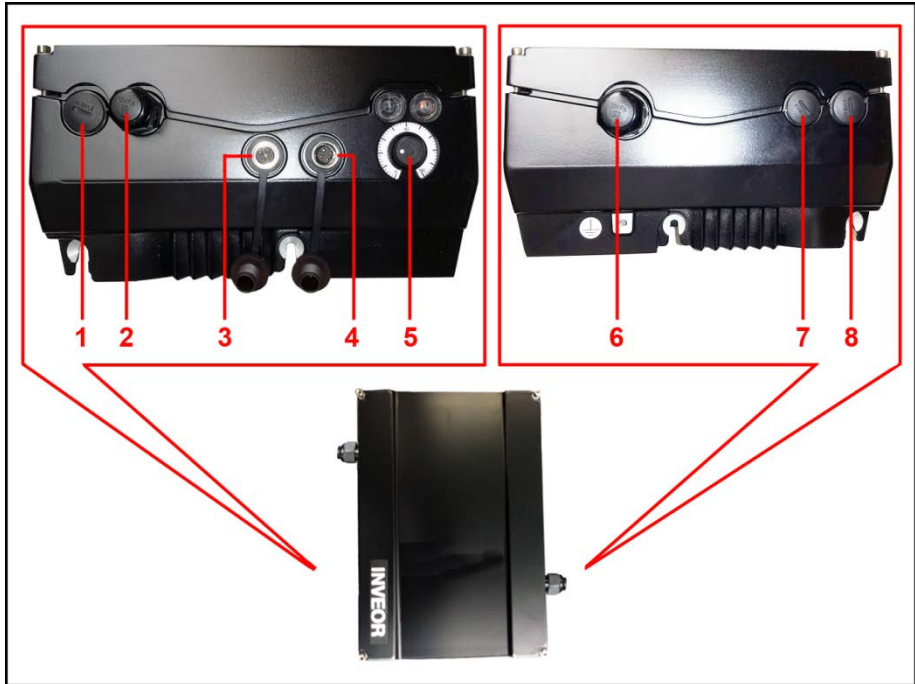

Fig.: 20 Connections size A "CANopen" / "Profibus"

Connections size A "CANopen" / "Profibus"	
1	Blind plug
2	Control line
3	CANopen / Profibus
4	MMI
5	Potentiometer
6	Grid connection
7	Blind plug STO (install EMC screw connection supplied in the package)
8	Blind plug STO (install EMC screw connection supplied in the package)

10.2 Connections size A "EtherCAT"

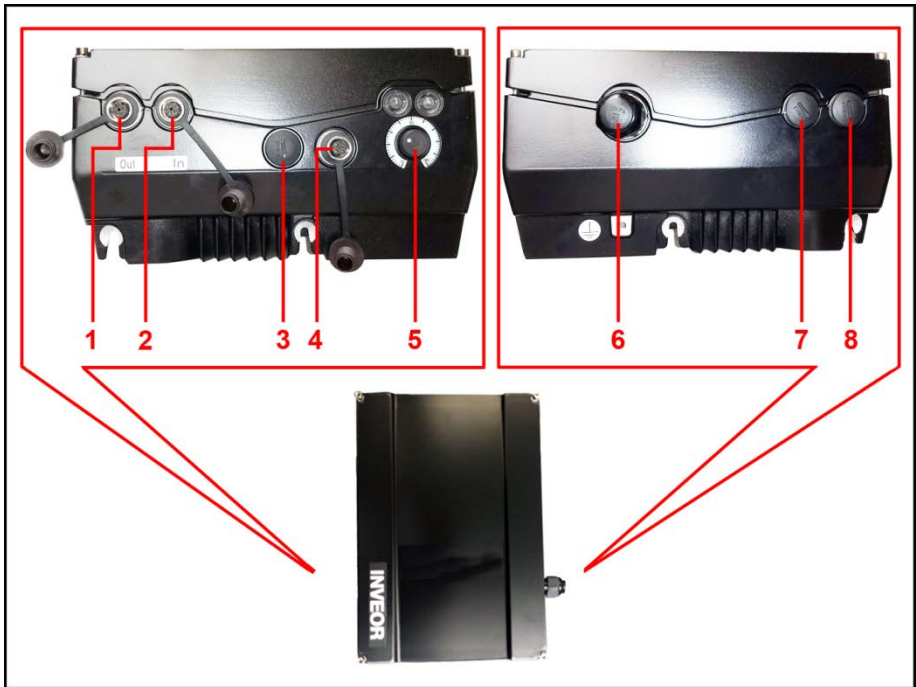

Fig.: 21 Size "EtherCAT"

Connections size A "EtherCAT"	
1	EtherCAT "Out"
2	EtherCAT "In"
3	Blind plug
4	MMI
5	Potentiometer
6	Grid connection
7	Blind plug STO (install EMC screw connection supplied in the package)
8	Blind plug STO (install EMC screw connection supplied in the package)

10.3 Connections sizes B - C "CANopen" / "Profibus"

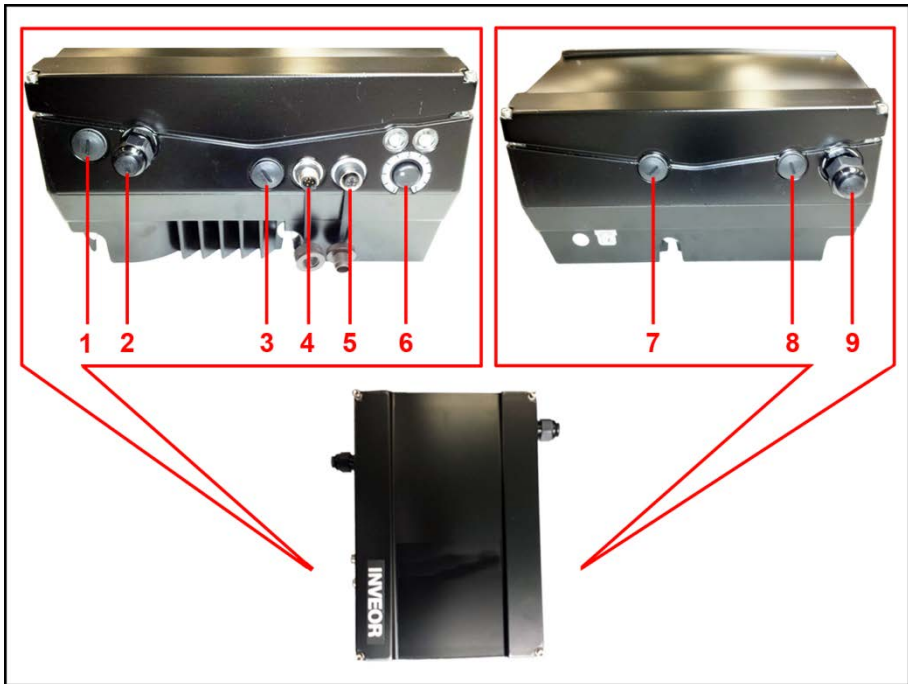

Fig.: 22 Connections sizes B - C "CANopen" / "Profibus"

Connections sizes B - C "CANopen" / "Profibus"	
1	Blind plug STO (install EMC screw connection supplied in the package)
2	Control line
3	Blind plug
4	CANopen / Profibus
5	MMI
6	Potentiometer
7	Blind plug STO (install EMC screw connection supplied in the package)
8	Blind plug STO (install EMC screw connection supplied in the package)
9	Grid connection

10.4 Connections sizes B - C "EtherCAT"

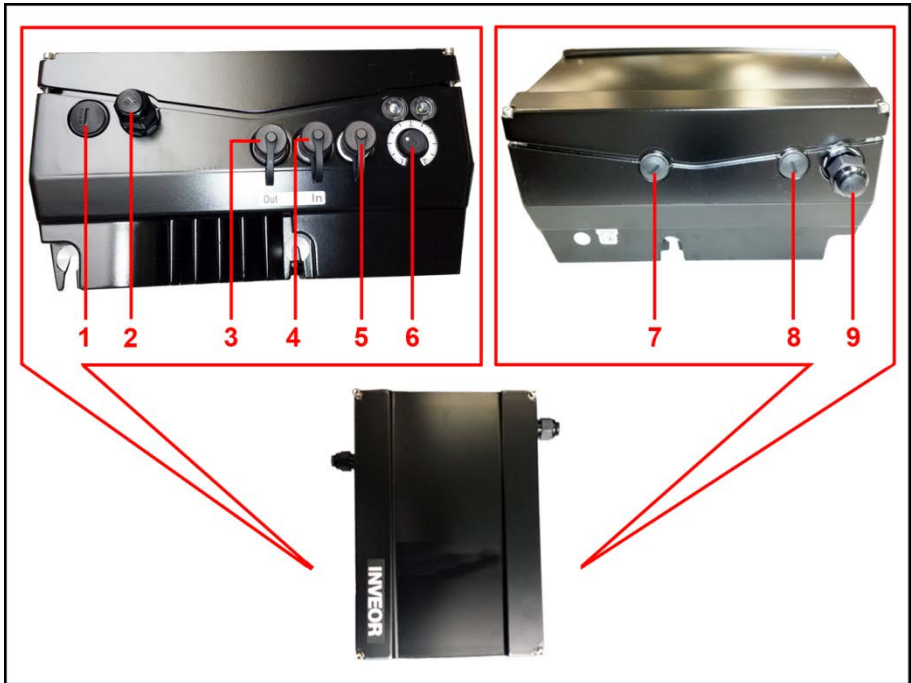

Fig.: 23 Connections sizes B - C "EtherCAT"

Connections size A "EtherCAT"	
1	Blind plug STO (install EMC screw connection supplied in the package)
2	Control line
3	EtherCAT "Out"
4	EtherCAT "In"
5	MMI
6	Potentiometer
7	Blind plug STO (install EMC screw connection supplied in the package)
8	Blind plug STO (install EMC screw connection supplied in the package)
9	Grid connection

10.5 Connections size D "CANopen" / "Profibus"

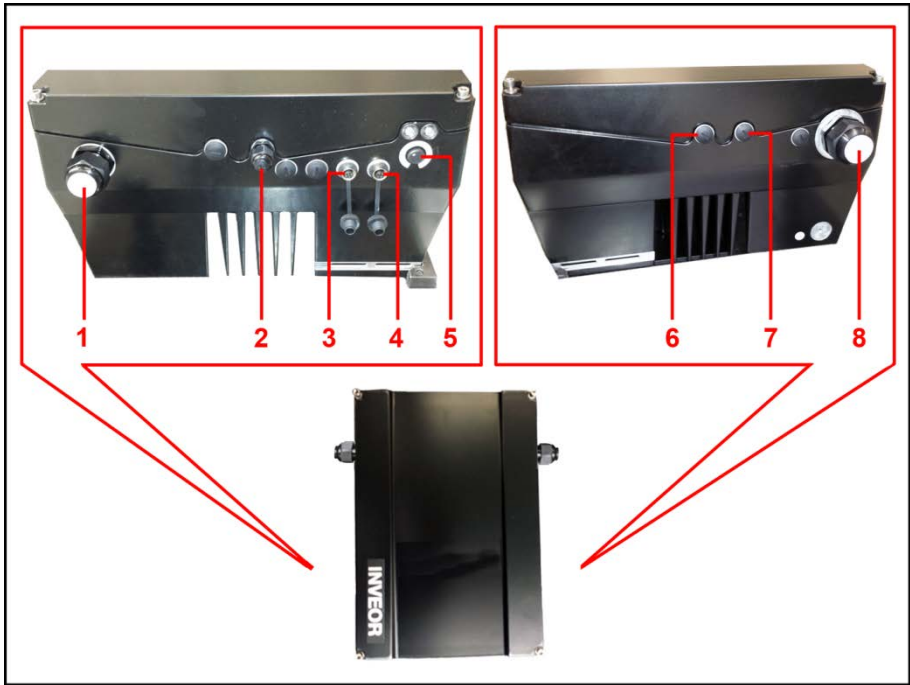

Fig.: 24 Connections size D "CANopen" / "Profibus"

Connections size D "CANopen" / "Profibus"	
1	Cable screw connection with blind plug
2	Control line
3	CANopen / Profibus
4	MMI
5	Potentiometer
6	Blind plug STO (install EMC screw connection supplied in the package)
7	Blind plug STO (install EMC screw connection supplied in the package)
8	Grid connection

10.6 Connections size D "EtherCAT"

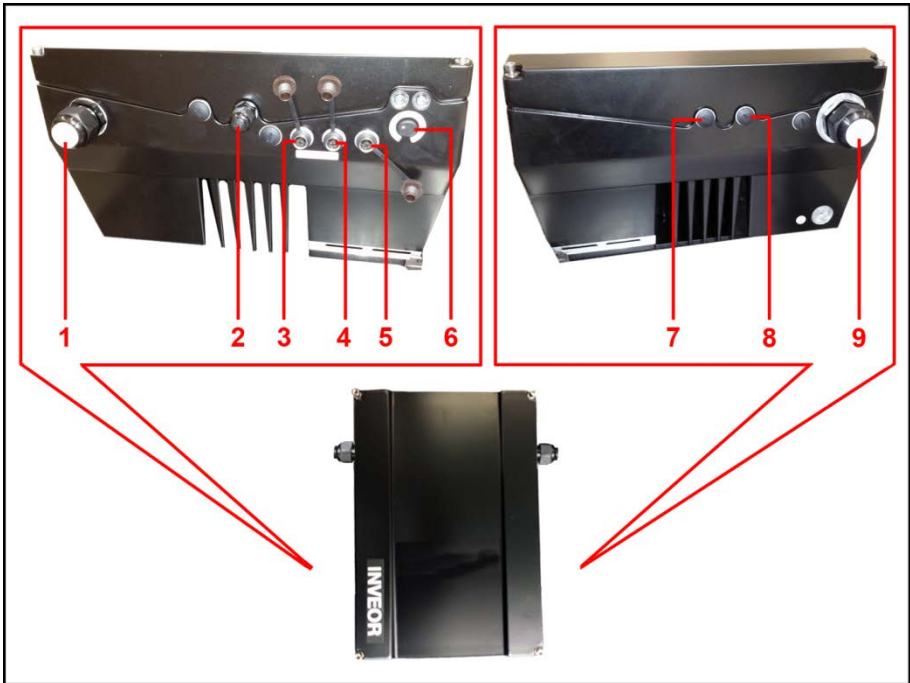

Fig.: 25 Connections size D "EtherCAT"

Connections size A "EtherCAT"	
1	Cable screw connection with blind plug
2	Control line
3	EtherCAT "Out"
4	EtherCAT "In"
5	MMI
6	Potentiometer
7	Blind plug; for the insertion of the STO connection cable, the EMC screw connection in the accompanying package must be installed
8	Blind plug; for the insertion of the STO connection cable, install the EMC screw connection in the accompanying package
9	Grid connection

10.7 STO connection cable

With reference to the STO connection line, the "elimination of errors with regard to short circuit" is achieved in accordance with DIN EN 13849-2 in that a separate, shielded cable is used for each channel. Shielding is to be applied at both ends.

If only one shielded cable is used for both STO channels, a safety switch must be used to detect possible crossovers between the channels to qualify for observation of the "elimination of errors short circuit".

The maximum cable length for the connection of the STO channels is 30m.

The cable cross-section is to be designed in such a way to ensure the required minimum input voltage of 18 V or 19.2 V during operation with OSSD signals.

Wiring instructions for control terminals X5 and X310:

Sizes A - D	
Terminals:	Plug terminal clamp with activation button (slot screwdriver, max. width 2.5 mm)
Connection cross-section:	0.5 to 1.5 mm ² , single-wire, AWG 20 to AWG 14
Connection cross-section:	0.75 to 1.5 mm ² , fine-wired, AWG 18 to AWG 14
Connection cross-section:	0.5 to 1.0 mm ² , fine-wired (core end sleeves with and without plastic collars)
Length of stripped insulation:	9 to 10 mm

10.8 Disassembly

See chapter 1 "General information" of the operating manual "INVEOR drive controller".

10.9 Commissioning

See chapter 1 "General information" of the operating manual "INVEOR drive controller".

The procedure is described as a flow chart in chapter 15.3.

10.9.1 STO validation

In the context of commissioning, it is absolutely necessary to request the STO function of the drive controller in order to ensure problem-free function.

To this purpose the STO function is requested with running motor. The motor must then run down.

The diagnosis function must also be checked. See chapter 8.1.

10.9.2 SS1 Validation

The INVEOR drive controller is not equipped with a safety-related input which provides the SS1 function.

The SS1 validation thus contains the check of the STO safety function (see 10.4.1) of the drive controller and the check of the external safety switching device, which requests the STO function upon expiration of the set time.

11. Dealing with malfunctions

11.1	Error detection and troubleshooting	71
11.2	Malfunction overview	72
11.3	Fault display	73
11.4	Fault-finding and troubleshooting	74

11.1 Error detection and troubleshooting

This chapter contains the following:

- a list of the LED flash codes for error recognition
- a description of error recognition using PC tools
- a list of errors and system errors
- notes on error detection with the MMI



DANGER

Risk of death due to electrical shock!

Death or serious injury!

De-energise device and secure it against being switched back on.

If damaged parts or components need replacing, only ever replace with original parts.



Danger due to electrical shock and discharge. Wait two minutes (discharge time of the capacitors) after shut-down

11.2 Malfunction overview

The driver controller shuts down if an error occurs. Consult the flash code table / PC tool for the corresponding error numbers.



IMPORTANT INFORMATION

Error messages can only be acknowledged once the error has been remedied.

Error messages can be acknowledged as follows:

- digital input (can be programmed)
- using the MMI (handheld controller)
- auto acknowledgement (parameter 1.181, page 89)
- switch device off and on again
- via fieldbus (CANOpen, Profibus DP, EtherCAT)

A list of possible fault messages can be found in chapter 6.2 of the operating manual for the INVEOR drive controller.

11.3 Fault display

When an error occurs, the LEDs on the drive control display a flashing code that allows the errors to be diagnosed.

The following table contains an overview:

Red LED	Green LED	State
		Boot loader active (flashing in turn)
		Operational (STO channels are not supplied with 24 V)
		Operation / Ready (STO channels are supplied with 24 V)
		Warning
		Error
		Identification of motor data
		Initialisation
		Firmware update
		Bus error operation
		Bus error ready for operation

Tab. 1: LED flash codes

Key



LED off



LED on



LED flashes



LED flashes quickly

11.4 Fault-finding and troubleshooting

Utilise the operating manual of the INVEOR sizes A - D for assistance in fault-finding and troubleshooting.

See chapter 6.2 "List of faults and system errors" of the operating manual "INVEOR drive controller".

12. Maintenance

See chapter 1 "General information" of the operating manual "INVEOR drive controller".

12.1 Safety function

The STO function is requested when the motor is running. The motor must then run down.

In accordance with the selected safety application (also see chapter 5), the correct functionality of the diagnosis or of the dynamic test must also be documented.

12.2 Checklist for maintenance

See chapter 1 "General information" of the operating manual "INVEOR drive controller".

13. Index

A

Abbreviations	16
Analogue input	59
Analogue output	59
Application instructions - Safety	45

C

Carrying out an internal diagnosis.....	52
Carrying out external diagnosis.....	52
CE marking	15
Classification IEC 60204-1	23
Classification IEC 61800-5-2	24
Classification one-channel (reduced SIL and PL)	30
Classification two-channel EN 62061 with external diagnosis	26
Classification two-channel EN 62061 without external diagnosis.....	25
Classification two-channel EN 62061, without dynamic testing	27
Classification two-channel EN ISO 13849-1 with dynamic testing	29
Classification two-channel EN ISO 13849-1 with external diagnosis.....	29
Classification two-channel EN ISO 13849-1 without external diagnosis	28
Connections size A CANopen / Profibus.....	62
Connections size A EtherCAT.....	63
Connections size D CANopen / Profibus.....	66
Connections size D EtherCAT	67
Connections sizes B - C CANopen / Profibus	64
Connections sizes B - C EtherCAT	65

D

Dealing with malfunctions.....	70
Diagnosis safety function	51
Digital input.....	58
Digital input (not safety-related).....	48
Digital output	58

E

Error detection and troubleshooting.....	71
External dynamic test	53
External STO input voltage	47

F

Fault display.....	73
Fault-finding and troubleshooting.....	74
Frequency.....	59

G

General safety instructions.....	20
----------------------------------	----

I

Internal auxiliary voltage	48
INVEOR connection diagram.....	56

L

Labels on the drive controller.....	13
Legal notice.....	2

M

Maintenance.....	75
Malfunction overview.....	72

P

Parameterisation	8
Parameterization	49
Principle of STO without external diagnosis	40

R

Restarting protection.....	46
----------------------------	----

S

Safety classification / characteristic values	22
Safety function	75
Safety functions.....	37
SS1.....	49
SS1 functional sequence	44
STO	49
STO connection cable.....	68
STO function (safe torque off).....	39
STO validation	69
STO with dynamic test.....	42
STO with external diagnosis	41

T

Technical data STO	34
Technical data, general	34
Terminal assignment	55
Terminal assignment X310	57
Terminal assignment X5	58
Type key/scope of application	31

W

Warning symbols.....	10
Warnings	9

14. Overview: Tables / Figures

14.1 List of tables

Table 1: Other applicable documents	8
Table 2: Abbreviations and terms	17
Table 3: Classification two-channel EN 62061, without external testing	25
Table 4: Classification two-channel EN 62061 with external diagnosis	26
Table 5: Classification two-channel EN 62061, with enhanced external testing	27
Table 6: Classification two-channel EN ISO 13849-1 without external testing	28
Table 7: Classification two-channel EN ISO 13849-1 with external diagnosis	29
Table 8: Classification two-channel EN ISO 13849-1 with enhanced external testing	29
Table 9: Classification one-channel IEC 61508 and EN ISO 13849	30
Table 10: Technical data STO	34

14.2 List of figures

Fig.: 1 Structure of warnings.....	9
Fig.: 2 Example of an information note.....	11
Fig.: 3 Symbols and icons used.....	12
Fig.: 4 Labels on the drive controller	13
Fig.: 5 Item designation (current).....	31
Fig.: 6 Item designation (future).....	32
Fig.: 7 OSSD test pulses, in this case 2 test pulses	35
Fig.: 8 STO input.....	36
Fig.: 9 Safety function STO	39
Fig.: 10 STO without external diagnosis.....	40
Fig.: 11 STO with external diagnosis.....	41
Fig.: 12 STO with dynamic test.....	42
Fig.: 13 Safety function SS1 without monitoring with brake ramp.....	43
Fig.: 14 SS1 function	44
Fig.: 15 Digital input (not safety-related).....	48
Fig.: 16 External dynamic test	54
Fig.: 17 Control connections.....	56
Fig.: 18 Terminal assignment X310.....	57
Fig.: 19 Terminal assignment X5.....	58
Fig.: 20 Connections size A "CANopen" / "Profibus".....	62
Fig.: 21 Size "EtherCAT"	63
Fig.: 22 Connections sizes B - C "CANopen" / "Profibus"	64
Fig.: 23 Connections sizes B - C "EtherCAT".....	65
Fig.: 24 Connections size D "CANopen" / "Profibus".....	66
Fig.: 25 Connections size D "EtherCAT"	67
Fig.: 26 Block diagram for quick start for ASM.....	81
Fig.: 27 Block diagram for quick start for SM.....	82

14.3 Appendix: Commissioning

14.3.1 Quick-start guide for asynchronous motors

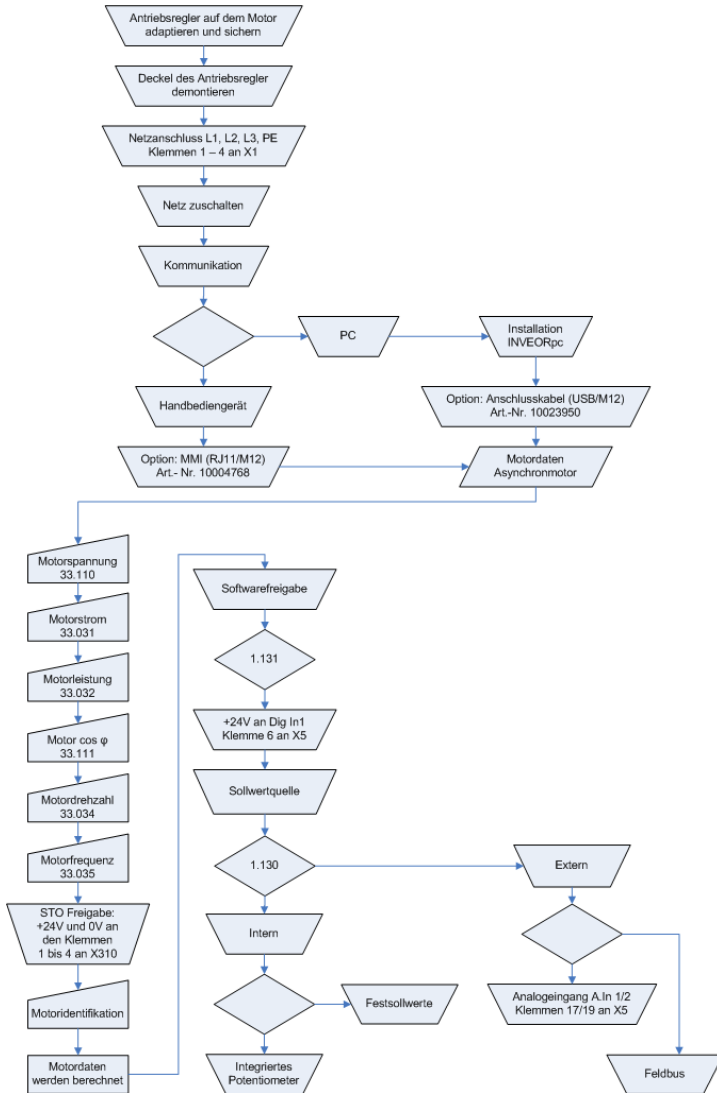

Fig.: 26 Block diagram for quick start for ASM

14.3.2 Quick-start guide for synchronous motors

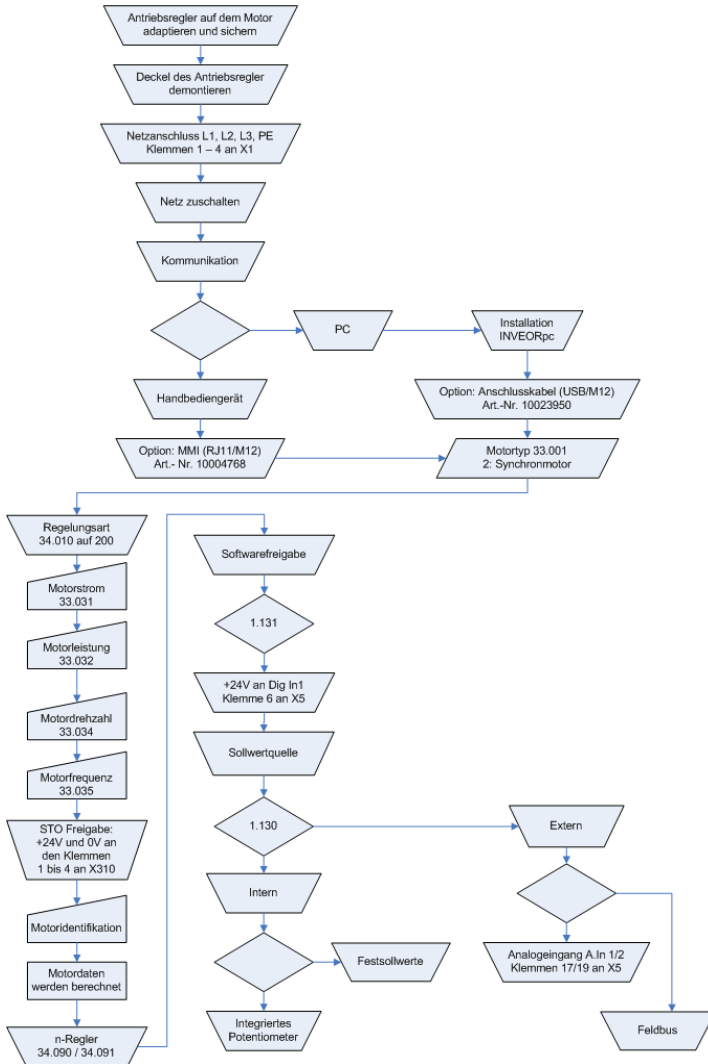

Fig.: 27 Block diagram for quick start for SM

Notes

KOSTAL

KOSTAL Industrie Elektrik GmbH
Lange Eck 11
58099 Hagen
Germany

Service-Hotline: +49 2331 8040-848
Phone: +49 2331 8040-800
Fax: +49 2331 8040-602

www.kostal-industrie-elektrik.com