



Smart  
connections.

Data sheet

**INVEOR M**

# INVEOR – "Smart connections." on five levels

## 1 The INVEOR

- IP65 protection class
- Integrated soft PLC
- Pre-fitted cable glands
- Fan-free design up to 7.5 kW
- Robust and vibration-resistant housing concept
- STO functional safety

## 3 Operation and observation

- Potentiometer
- M12 RS485 service interface
- Integrated foil keypad
- MMI handheld controller
- MMI cover option
- Touch operating terminal
- PC software: KOSTAL INVERTERpc
- App: KOSTAL INVERTERapp



## 2 Communication

- CANopen
- PROFINET
- EtherCAT
- PROFINET
- MODBUS RTU
- SERCOS the automation bus
- Bluetooth

## 4 Motor adaptations

- Robust and vibration-resistant adapter concept
- Motor adapter concept compatible with all commercially available motors

## 5 Control process

- IE1, IE2, IE3, IE4: for asynchronous motors and synchronous motors

## Overview of INVEOR M sizes



a

A

B

C

D

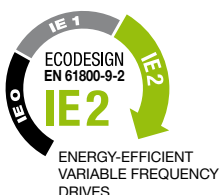

## 230 V devices, technical data for INVEOR M

Size	α				A				
Recommended motor rating <sup>1)</sup> [kW]	0.25	0.37	0.55	0.75	0.37	0.55	0.75	1.1	1.5
Supply voltage	1 x 100 V AC -15 %...230 V AC +10 % 140 V DC -15 %...320 V DC +10 % <sup>4)</sup>								
Grid frequency	50/60 Hz ± 6%								
Network configurations	TN / TT / IT (option)				TN / TT				
Line current [A]	4.5	4.5	5.8	7.3	4.5	5.6	6.9	9.2	13.2
Rated current output eff. [IN at 8 kHz]	1.4	2.2	2.7	3.3	2.3	3.2	3.9	5.2	7
Min. brake resistance [Ω]	-				50				
Overload for 60 sec.	150 %								125 %
Switching frequency	4 kHz, 8 kHz, 16 kHz, (factory setting 8 kHz)								
Output frequency	0 Hz – 400 Hz								
Mains cycles of operation / restart	Every 2 min.								
DIN EN 61800-5 touch current	< 10 mA <sup>2)</sup>								
Protective function	Overvoltage and undervoltage, I <sup>2</sup> t restriction, short-circuit, ground leak, motor and variable frequency drive temperature, stall prevention, blocking detection, PID dry run protection								
Software functions	Process control (PID controller), fixed frequencies, data record changeover, flying restart, motor current limit								
Soft PLC	IEC61131-3, FBD, ST, AWL								
Housing	Plastic adapter plate / aluminium die-cast casing				Two-part aluminium die-cast casing				
Dimensions [L x W x H] mm	187 x 126 x 70		187 x 126 x 80		233 x 153 x 120				
Weight including adapter plate	1.5 kg				3.9 kg				
Protection class [IPxy]	IP 65								
Cooling	Passive cooling								Active "internal" cooling
Ambient temperature	-10 °C (non-condensing) to +40 °C (50 °C with derating)								up to 35 °C / 40 °C <sup>5)</sup>
Storage temperature	-25 °C...+85 °C								
Altitude of the installation location	Up to 1000 m above sea level / over 1000 m with reduced performance (1 % per 100 m) / above 2000 m see operating manual								
Relative air humidity	≤ 96 %, condensation not permitted.								
Vibration resistance (DIN EN 60068-2-6)	50 m/s <sup>2</sup> , 60...160 Hz <sup>3)</sup>								10 m/s <sup>2</sup> ; 5...200 Hz <sup>3)</sup>
Shock resistance (DIN EN 60068-2-27)	300 m/s <sup>2</sup> , 11ms, 3 layers								100 m/s <sup>2</sup>
EMC (DIN-EN-61800-3)	C2				C1				
Certificates and conformity	  								

Size	α		A		
Application circuit board model	Standard		Basic 0.37-1.1 kW	Standard 0.37-1.1 kW	Basic 1.5 kW
I/O interfaces	2 DI / 1 DO / 1 AI / - AO / 1 relay		2 DI / 1 DO / 1 AI / - AO / - relay	4 DI / 2 DO / 2 AI / 1 AO / 2 relays	2 DI / 1 DO / 1 AI / - AO relay
Potentiometer on device	Accessories		Option	Option	Option
Foil keypad	Option		Option	Option	-
MMI option	-		Option	Option	-
Internal power supply	24 V DC, 100 mA / 10 V DC, 30 mA / short-circuit proof				24 V DC, 100 mA / short-circuit proof
External feed-in 24 V DC	-		-	24 V DC +/-15 %	-
Fieldbus integrated	Modbus RTU				
Fieldbus option	CANopen		-	CANopen / PROFIBUS / PROFINET / EtherCAT / Sercos III	-

Technical data for 230 V devices INVEOR M (subject to technical changes)

<sup>1)</sup> Recommended motor rating (4-pole asynch. motor) is given based on the 230 V AC supply voltage.



<sup>2)</sup> With 1LA7 asynchronous motor, motor-mounted

<sup>3)</sup> Installation- and application-related resonant frequencies can damage the devices.

<sup>4)</sup> In compliance with the overvoltage category

<sup>5)</sup> For 40 m<sup>3</sup>/h / 60 m<sup>3</sup>/h cooling air flow

# 400 V devices, technical data for INVEOR M

Sizes	A				B			C		D			
Recommended motor rating <sup>1)</sup> [kW]	0.55	0.75	1.1	1.5	2.2	3.0	4.0	5.5	7.5	11.0	15.0	18.5	22.0
Supply voltage	3 x 200 V AC -10 %...480 V AC +10 %   280 V DC -10 %...680 V DC +10 % <sup>4)</sup>												
Grid frequency	50/60 Hz ± 6 %												
Network configurations	TN / TT												
Line current [A]	1.4	1.9	2.6	3.3	4.6	6.2	7.9	10.8	14.8	23.2	28.2	33.2	39.8
Rated current output eff. [IN at 8 kHz]	1.7	2.3	3.1	4.0	5.6	7.5	9.5	13.0	17.8	28.0	34.0	40.0	48.0
Min. brake resistance [Ω]	100				50			50		30			
Overload for 60 sec. in %	150												130
Switching frequency	4 kHz, 8 kHz, 16 kHz, (factory setting 8 kHz)									4 kHz - 16 kHz (factory setting 4 kHz)			
Output frequency	0 Hz – 400 Hz												
Nominal output apparent power [kVA]	1.06	1.43	1.93	2.49	3.49	4.68	5.92	8.11	11.1	17.46	21.2	24.94	29.93
Mains cycles of operation / restart	Unlimited <sup>5)</sup>									2 min.			
DIN EN 61800-5 touch current	< 3.5 mA <sup>2)</sup>												
Protective function	Overvoltage and undervoltage, I <sup>2</sup> t restriction, short-circuit, ground leak, motor and variable frequency drive temperature, stall prevention, blocking detection, PID dry run protection												
Software functions	Process control (PID controller), fixed frequencies, data record changeover, flying restart, motor current limit												
Soft PLC	IEC61131-3, FBD, ST, AWL												
Housing	Two-part aluminium die-cast casing												
Dimensions [L x W x H] mm	233 x 153 x 120				270 x 189 x 140			307 x 223 x 181		414 x 294 x 232			
Weight including adapter plate	3.9 kg				5.0 kg			8.7 kg		21.0 kg			
Protection class	IP 65									IP 55			
Cooling	Passive cooling									Active cooling			
Ambient temperature	-40 °C (non condensing) to +50 °C (without derating)									-40 up to +50 °C (8kHz)		-40 up to +50 °C (4kHz)	
Storage temperature	-40 °C...+85 °C												
Altitude of the installation location	Up to 1000 m above sea level / over 1000 m with reduced performance (1 % per 100 m) / above 2000 m see operating manual												
Relative air humidity	≤ 96 %, condensation not permitted.												
Vibration resistance (DIN EN 60068-2-6) standard variant	50 m/s <sup>2</sup> ; 60...160 Hz <sup>3)</sup>									30 m/s <sup>2</sup>   60...160 Hz <sup>3)</sup>			
Vibration resistance (DIN EN 60068-2-6) HD variant	-				50 m/s <sup>2</sup>   60...160Hz <sup>3)</sup> ; Noise: 10-1000 Hz <sup>3)</sup>								
Shock resistance (DIN EN 60068-2-27) standard variant & HD variant	300 m/s <sup>2</sup> , 11ms, 3 layers												
EMC (DIN-EN-61800-3)	C2												
Energy efficiency class (EN 61800-9-2)	IE2												
Certificates and conformity													

Size	A, B, C	A, B, C, D	
Application circuit board model	Basic	Standard	Functional safety
I/O interfaces	2 DI / 1 DO / 1 AI / - AO / - relay	4 DI / 2 DO / 2 AI / 1 AO / 2 relays	4 DI / 2 DO / 2 AI / 1 AO / - relay / 2 STO channels
Potentiometer on device	Option	Option	Option
Foil keypad	Option	Option	Option
MMI option	Option	Option	Option
Internal power supply	24 V DC, 100 mA / 10 V DC, 30 mA / short-circuit proof		
External feed-in 24 V DC	-	24 V DC +/-15 %	24 V DC +/-15 %
Fieldbus integrated	Modbus RTU		
Fieldbus option	-	CANopen / PROFIBUS / PROFINET / EtherCAT / Sercos III	

Technical data for 400 V devices INVEOR M (subject to technical changes)

<sup>1)</sup> Recommended motor rating (4-pole asynch. motor) is given based on the 400 V AC supply voltage.

<sup>2)</sup> With 1LA7 asynchronous motor, motor-mounted

<sup>3)</sup> Installation- and application-related resonant frequencies can damage the devices.

<sup>4)</sup> In compliance with the overvoltage category

<sup>5)</sup> < 3 s may result in power failure/intermediate circuit undervoltage faults



# Variable frequency drive losses in accordance with EN 61800-9-2

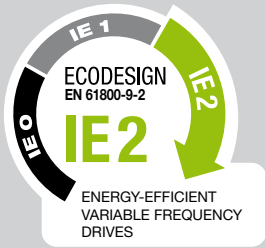

INVEOR variable frequency drives meet the most stringent of energy efficiency requirements.

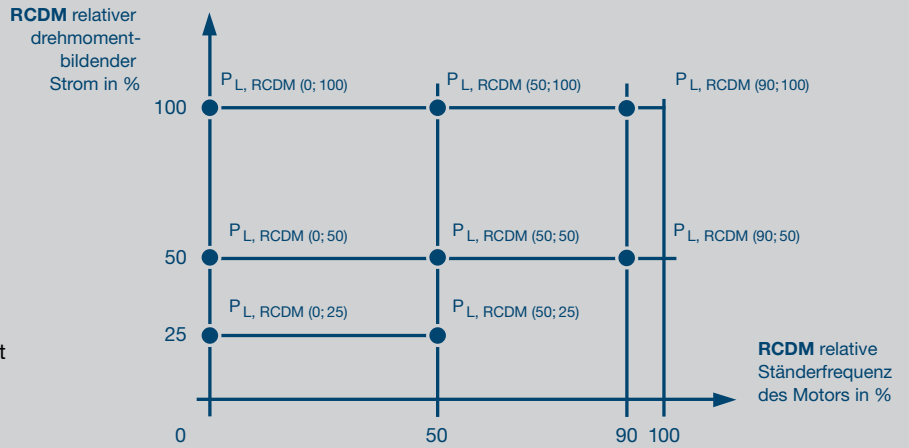

Device	Supply voltage [V]	Nominal current [A]	Measurement (90; 100)	Measurement (50; 100)	Measurement (10; 100)	Measurement (90; 50)	Measurement (50; 50)	Measurement (10; 50)	Measurement (50; 25)	Measurement (10; 25)	Standby Losses [W]	IE class
			Relative losses [%] <sup>1) 2) 3)</sup>									
Size A 0.55 kW	400	1.7	20	19	21	19	17	18	16	18	5	IE2
			1.9	1.8	2	1.8	1.6	1.7	1.5	1.7		
Size A 0.75 kW	400	2.3	26	25	26	19	19	21	19	20	5	IE2
			1.8	1.8	1.8	1.3	1.3	1.4	1.3	1.4		
Size A 1.1 kW	400	3.1	33	33	32	24	26	25	19	21	5	IE2
			1.7	1.7	1.6	1.3	1.4	1.3	1	1.1		
Size A 1.5 kW	400	4.0	45	38	41	29	31	30	32	26	5	IE2
			1.8	1.5	1.6	1.2	1.2	1.2	1.3	1		
Size B 2.2 kW	400	5.6	58	55	56	42	40	42	32	37	5	IE2
			1.7	1.6	1.6	1.2	1.1	1.2	0.9	1		
Size B 3.0 kW	400	7.5	81	87	71	54	53	52	43	46	5	IE2
			1.7	1.9	1.5	1.2	1.1	1.1	0.9	1		
Size B 4.0 kW	400	9.5	103	96	94	67	62	64	53	53	5	IE2
			1.7	1.6	1.6	1.1	1	1.1	0.9	0.9		
Size C 5.5 kW	400	13.0	153	125	123	77	73	73	53	58	5	IE2
			1.9	1.5	1.5	0.9	0.9	0.9	0.7	0.7		
Size C 7.5 kW	400	17.8	233	187	171	104	95	95	74	81	5	IE2
			2.1	1.7	1.5	0.9	0.9	0.9	0.7	0.7		
Size D 11.0 kW	400	28.0	268	234	242	152	140	150	107	116	13	IE2
			1.5	1.3	1.4	0.9	0.8	0.9	0.6	0.7		
Size D 15.0 kW	400	34.0	339	293	297	185	165	174	123	133	13	IE2
			1.6	1.4	1.4	0.9	0.8	0.8	0.6	0.6		
Size D 18.5 kW	400	40.0	407	347	347	212	189	200	135	147	13	IE2
			1.6	1.4	1.4	0.9	0.8	0.8	0.5	0.6		
Size D 22.0 kW	400	48.0	526	448	448	262	237	248	172	183	13	IE2
			1.8	1.5	1.5	0.9	0.8	0.8	0.6	0.6		

<sup>1)</sup> Loss values were determined at 4 kHz switching frequency  
<sup>2)</sup> Loss values include 10% supplement in accordance with EN 50598 standard  
<sup>3)</sup> Relative losses in relation to the device's rated apparent power

# KOSTAL

## Contact

KOSTAL Industrie Elektrik GmbH & Co. KG  
Lange Eck 11  
58099 Hagen  
Deutschland

Telephone: +49 2331 8040-468

Fax: +49 2331 8040-602

info-industrie@kostal.com

[www.kostal-drives-technology.com](http://www.kostal-drives-technology.com)

